

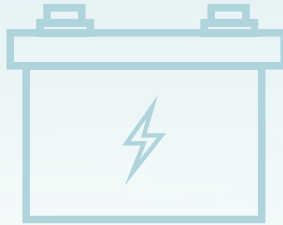

NPB & NPP Series Installation Manual



Intelligent Battery Charger

• High Reliable Intelligent Battery Charger •

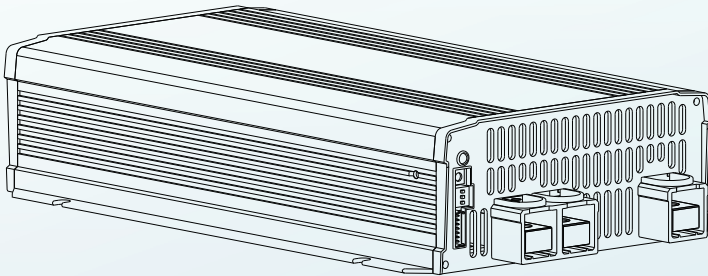

NPB及NPP系列為明緯所推出新一代高功率密度智能充電器，NPB-120/240/360系列採用高效率硬體線路設計，產品可高效率且穩定運作，NPB-450/450NFC/750/1200/1700系列產品運用全數位化智能晶片設計，產品擁有小型化、高效化、智能化三大特點。設計上採用高效率硬體線路與微處理器電源管理，並首創智能偵壓功能，提供充電模式/預設曲線/智能偵壓功能設定，以因應不同廠牌或不同種類電池(鉛酸電池：如flooded加水式、Gel膠體式、AGM吸附玻璃纖維等，或鋰電池：如鋰鐵、鋰錳、鋰三元等)所需求的特殊充電曲線與各種電池保護功能之調整，亦可透過本身內建的智慧型通訊介面，由使用者自行設定或修改充電參數與曲線，達到各種客製化之電池充電應用。您可針對某一區段的充電電壓、充電電流、截止電壓/電流等參數進行調整，亦可取消對電池的特定保護功能。NPP全系列裝備了充電器及電源供應器模式，此兩種模式可依據使用者需求自由設定。充電器模式下，提供三段式充電功能，充電電壓及電流可依不同電池種類進行調整。如切換至電源供應器模式，則可進行一般性負載驅動。NPB及NPP系列彈性及智能的設計可因應日益複雜的電池應用提供完美的解決方案。

目錄

1.操作安全注意事項	1	6.CANBus通訊	44
2.產品簡介	2	6.1 CANBus相關規格	44
2.1 機型命名	2	6.2 CANBus匯流排位址設定	45
2.2 產品特點	2	6.3 CANBus命令支援表	46
2.3 電氣規格表	3	6.4 通訊範例	52
2.4 安規一覽表	19	6.5 CANBus數值範圍與誤差	58
2.5 減額曲線	20	7.NPB-450-XXNFC APP操作說明	63
2.6 產品機構圖	21	7.1 使用前準備	63
3.安裝說明	24	7.2 相容的手機或移動裝置	63
3.1 安裝注意事項	24	7.3 設定步驟	63
3.2 安裝步驟	24	7.4 APP功能說明	64
3.3 電池配線選用	25	7.5 NFC使用注意事項	65
3.4 電池類型與容量建議	25	7.6 APP常見問題	66
3.5 電池串聯與並聯	26	8.保護功能及異常排除	67
4.面板與燈號顯示	27	8.1 保護功能	67
4.1 面板功能說明	27	8.2 異常排除	68
4.2 LED燈號	30	9.保固	69
4.3 功能腳位說明(NPB)	31	10.環境宣告資訊	70
4.4 功能腳位說明 (NPB-450NFC)	32		
4.5 功能腳位說明(NPP)	33		
5.功能與操作	34		
5.1 功能差異表	34		
5.2 功能說明	34		
5.3 操作模式(2/3段式充電)	38		
5.4 充電曲線設定	41		
5.5 回復原廠設定	43		

1.操作安全注意事項

- 僅適用於鉛酸電池(加水式、膠體式、吸附玻璃纖維式等)或鋰電池(鋰鐵、鋰錳、鋰三元等)。
- 充電器需置放於通風良好、乾燥之場合，不可暴露於雨中或雪中。
- 請勿拆解或變更產品上的任何零件。
- 電池連接至充電器線長儘可能短(建議約50cm~100cm)，避免線壓降過大，拉長電池充飽時間。
- 使用前請先確認充電電壓和充電電流的設定符合電池要求。
- 電池串聯充電時，新舊電池不可混合做串聯使用。
- 連接或拔除連接線時，必須確認充電器是處於關閉的狀態。
- 啟用智能偵壓模式前請詳讀相關說明，具BMS(電池管理系統)之鋰電池才可使用此功能。
- 本設備不適合在兒童可能會出現的場所使用。
- 設備的保護接地導體要連接到設施的保護接地導體(例如：用電源軟線連接到具有接地連接的插座)。
- 僅室內使用。 

2.產品簡介

2.1 機型命名



2.2 產品特點

- 適用鉛酸電池(加水式、膠體式及吸附玻璃纖維式)或鋰電池(鋰鐵、鋰錳、鋰三元)充電
- 2/3段式充電曲線切換選擇
- 四條預設充電曲線選取設定(僅NPB-450/450NFC/750/1200/1700)
- 內建主動式PFC功能
- 支援CANBus 介面 (僅NPB-450/450NFC/750/1200/1700)
- 保護種類: 短路/過電壓/過溫度/電池反極性
(電池反極性僅NPB系列)
- 智能偵壓充電 (僅NPB-450/450NFC/750/1200/1700 限用鋰電池)
- 充電器或電源供應器模式彈性切換(僅NPP-450/750/1200/1700)
- LED燈: 狀態/異常顯示
- 通過DEKRA/UL/EAC/CE/UKCA 國際認證
- 3年長效保固

2.3 電器規格表

NPB-120系列

MODEL	NPB-120-12□			NPB-120-24□			NPB-120-48□			
	□ =XLR,AD1,TB									
OUTPUT	BOOST CHARGE VOLTAGE (Vboost)(default)	14.4V	28.8V	57.6V						
	FLOAT CHARGE VOLTAGE (Vfloat)(default)	13.8V	27.6V	55.2V						
	VOLTAGE ADJUSTABLE RANGE	10.5 ~ 15.2V	21 ~ 30.4V	42 ~ 60.8V						
	OUTPUT CURRENT <small>Note.5</small>	6.8A	4A	2A						
	CURRENT ADJUSTABLE RANGE	50% ~ 100%								
	MAX. POWER <small>Note.3</small>	103.4W	121.6W	121.6W						
	RECOMMENDED BATTERY CAPACITY (AMP HOURS) <small>Note.4</small>	20 ~ 90AH	15 ~ 50AH	7 ~ 25AH						
INPUT	VOLTAGE RANGE <small>Note.5</small>	90 ~ 264VAC 127 ~ 370VDC								
	FREQUENCY RANGE	47 ~ 63Hz								
	POWER FACTOR (Typ.)	PF>0.98/115VAC, PF>0.92/230VAC@12V, PF>0.93/230VAC@24/48V at full load								
	EFFICIENCY (Typ.)	XLR	86.5%	89%	90.5%					
		AD1	86.5%	89%	90.5%					
		TB	87%	89.5%	90.5%					
	AC CURRENT (Typ.)	1.5A/115VAC	0.8A/230VAC							
INRUSH CURRENT (Typ.)	COLD START 55A at 230VAC									
PROTECTION	SHORT CIRCUIT <small>Note.6</small>	Protection type : Constant current limiting, charger will shutdown after 5 sec, re-power on to recover								
	OVER VOLTAGE	16 ~ 20V	32 ~ 40V	64 ~ 75V						
	REVERSE POLARITY	By internal fuse open								
	OVER TEMPERATURE	Shut down O/P voltage, recovers automatically after temperature goes down								
FUNCTION	CHARGING CURVE	2 or 3 stage adjustable by DIP S.W								
ENVIRONMENT	WORK TEMP.	-30 ~ +70°C (Refer to "Derating Curve")								
	WORKING HUMIDITY	20 ~ 95% RH non-condensing								
	STORAGE TEMP., HUMIDITY	-40 ~ +85°C, 10 ~ 95% RH non-condensing								
	TEMP. COEFFICIENT	±0.05%/°C (0 ~ 50°C)								
	VIBRATION	10 ~ 500Hz, 2G 10min./1cycle, 60min. each along X, Y, Z axes								
OTHER	MTBF	631.8K hrs min. Telcordia SR-332(Bellcore) ; 225.8K hrs min. MIL-HDBK-217F (25°C)								
	DIMENSION	180*96*49mm (L*W*H)								
	PACKING	1.3Kg; 10pcs/14Kg/1.13CUFT								

NPB-240系列

MODEL	NPB-240-12□			NPB-240-24□			NPB-240-48□			
	□ =XLR,AD1,TB									
OUTPUT	BOOST CHARGE VOLTAGE (Vboost)(default)	14.4V	28.8V	57.6V						
	FLOAT CHARGE VOLTAGE (Vfloat)(default)	13.8V	27.6V	55.2V						
	VOLTAGE ADJUSTABLE RANGE	10.5 ~ 15.2V	21 ~ 30.4V	42 ~ 60.8V						
	OUTPUT CURRENT <small>Note.5</small>	13.5A	8A	4A						
	CURRENT ADJUSTABLE RANGE	50% ~ 100%								
	MAX. POWER <small>Note.3</small>	205.2W	243.2W	243.2W						
	RECOMMENDED BATTERY CAPACITY (AMP HOURS) <small>Note.4</small>	55 ~ 180AH	30 ~ 100AH	15 ~ 50AH						
INPUT	VOLTAGE RANGE <small>Note.5</small>	90 ~ 264VAC 127 ~ 370VDC								
	FREQUENCY RANGE	47 ~ 63Hz								
	POWER FACTOR (Typ.)	PF>0.98/115VAC, PF>0.95/230VAC at full load								
	EFFICIENCY (Typ.)	XLR	88.5%	92%	92.5%					
		AD1	88.5%	92%	92.5%					
		TB	89%	92%	93%					
	AC CURRENT (Typ.)	3A/115VAC	1.5A/230VAC							
INRUSH CURRENT (Typ.)	COLD START 50A at 230VAC									
PROTECTION	SHORT CIRCUIT <small>Note.6</small>	Protection type : Constant current limiting, charger will shutdown after 5 sec, re-power on to recover								
	OVER VOLTAGE	16 ~ 20V	32 ~ 40V	64 ~ 75V						
	REVERSE POLARITY	By internal fuse open								
	OVER TEMPERATURE	Shut down O/P voltage, recovers automatically after temperature goes down								
FUNCTION	CHARGING CURVE	2 or 3 stage adjustable by DIP S.W								
ENVIRONMENT	WORK TEMP.	-30 ~ +70°C (Refer to "Derating Curve")								
	WORKING HUMIDITY	20 ~ 95% RH non-condensing								
	STORAGE TEMP., HUMIDITY	-40 ~ +85°C, 10 ~ 95% RH non-condensing								
	TEMP. COEFFICIENT	±0.05%/°C (0 ~ 50°C)								
	VIBRATION	10 ~ 500Hz, 2G 10min./1cycle, 60min. each along X, Y, Z axes								
OTHER	MTBF	428.3K hrs min. Telcordia SR-332(Bellcore) ; 157.5K hrs min. MIL-HDBK-217F (25°C)								
	DIMENSION	180*96*49mm (L*W*H)								
	PACKING	1.3Kg; 10pcs/14Kg/1.13CUFT								

NPB-360系列

MODEL		NPB-360-12□ □=XLR,AD1,TB	NPB-360-24□	NPB-360-48□	
OUTPUT	BOOST CHARGE VOLTAGE (Vboost)(default)	14.4V	28.8V	57.6V	
	FLOAT CHARGE VOLTAGE (Vfloat)(default)	13.8V	27.6V	55.2V	
	VOLTAGE ADJUSTABLE RANGE	10.5 ~ 15.2V	21 ~ 30.4V	42 ~ 60.8V	
	OUTPUT CURRENT Note.5	20A	12A	6A	
	CURRENT ADJUSTABLE RANGE	50% ~ 100%			
	MAX. POWER Note.3	304W	364.8W	364.8W	
	RECOMMENDED BATTERY CAPACITY (AMP HOURS) Note.4	65 ~ 195AH	40 ~ 125AH	20 ~ 65AH	
INPUT	VOLTAGE RANGE Note.5	90 ~ 264VAC 127 ~ 370VDC			
	FREQUENCY RANGE	47 ~ 63Hz			
	POWER FACTOR (Typ.)	PF>0.98/115VAC, PF>0.95/230VAC at full load			
	EFFICIENCY (Typ.)	XLR	87%	91%	92%
		AD1	87%	91%	92%
		TB	88.5%	92%	92.5%
	AC CURRENT (Typ.)	4.5A/115VAC 2.2A/230VAC			
INRUSH CURRENT (Typ.)	COLD START 50A at 230VAC				
PROTECTION	SHORT CIRCUIT Note.6	Protection type : Constant current limiting, charger will shutdown after 5 sec, re-power on to recover			
	OVER VOLTAGE	16 ~ 20V	32 ~ 40V	64 ~ 75V	
	REVERSE POLARITY	By internal fuse open			
	OVER TEMPERATURE	Shut down O/P voltage, recovers automatically after temperature goes down			
FUNCTION	CHARGING CURVE	2 or 3 stage adjustable by DIP S.W			
	FAN CONTROL (Typ.)	Internal RTH3 \geq 50°C Fan ON, \leq 45°C Fan OFF			
ENVIRON- MENT	WORK TEMP.	-30 ~ +70°C (Refer to "Derating Curve")			
	WORKING HUMIDITY	20 ~ 95% RH non-condensing			
	STORAGE TEMP., HUMIDITY	-40 ~ +85°C, 10 ~ 95% RH non-condensing			
	TEMP. COEFFICIENT	\pm 0.05%/°C (0 ~ 50°C)			
VIBRATION	10 ~ 500Hz, 2G 10min./1cycle, 60min. each along X, Y, Z axes				
OTHER	MTBF	434.8K hrs min. Telcordia SR-332(Bellcore) ; 173.9K hrs min. MIL-HDBK-217F (25°C)			
	DIMENSION	180*96*49mm (L*W*H)			
	PACKING	1.3Kg; 10pcs/14Kg/1.13CUFT			

NPB-450系列

MODEL		NPB-450-12	NPB-450-24	NPB-450-48	NPB-450-72
OUTPUT	BOOST CHARGE VOLTAGE (Vboost)(default)	14.4V	28.8V	57.6V	72V
	FLOAT CHARGE VOLTAGE (Vfloat)(default)	13.8V	27.6V	55.2V	69V
	CHARGE VOLTAGE RANGE Note.3	10.5 ~ 21V	21 ~ 42V	42 ~ 80V	54 ~ 100V
	MAX. OUTPUT CURRENT (CC) Note.4	25A	13.5A	6.8A	5.5A
	MAX. POWER Note.4	420W	453.6W	456.96W	462W
	RECOMMENDED BATTERY CAPACITY (AMP HOURS) Note.5	90 ~ 300AH	45 ~ 155AH	24 ~ 80AH	19 ~ 64AH
	LEAKAGE CURRENT FROM BATTERY (Typ.)	<1mA			
	INPUT	VOLTAGE RANGE Note.6	90 ~ 264VAC 127 ~ 370VDC		
FREQUENCY RANGE		47 ~ 63Hz			
POWER FACTOR (Typ.)		PF>0.98/115VAC, PF>0.95/230VAC at full load			
EFFICIENCY (Typ.) Note.7		92%	93%	93%	93%
AC CURRENT (Typ.)		4.5A/115VAC 2.2A/230VAC			
INRUSH CURRENT (Typ.)		COLD START 50A at 230VAC			
LEAKAGE CURRENT		<0.75mA/240VAC			
PROTECTION	SHORT CIRCUIT Note.8	Protection type : Constant current limiting, charger will shutdown after 5 sec, re-power on to recover			
	OVER VOLTAGE Note.9	21.5 ~ 26V	43 ~ 52V	82 ~ 100V	102 ~ 120V
	REVERSE POLARITY	Protected internal reverse detection, No damage, re-power on to recover after fault condition is removed			
	OVER TEMPERATURE	Shut down O/P voltage, recovers automatically after temperature goes down			
FUNCTION	CHARGING CURVE	2 or 3 stage selectable through DIP S.W on panel, or SBP-001 with computer			
	CHARGING PARAMETERS PROGRAMMABLE	Programmable: Constant current(CC), Tapper current(TC), Constant voltage(CV) and Float voltage(FV) can be set through SBP-001 with computer Manual setting: 4 built-in charging curves adjustable via DIP S.W on panel, Please refer to function manual for more detail			
	AUTO RANGING CHARGING CURVE (Typ.)	Please refer to functin manual for more detail (page 8) Charging current adjustable 50~100% by via potentiometer on panel (Only for auto ranging mode)			
	CANBUS INTERFACE	CANBus 2.0B, Can control, Setting and monitoring(Vo,lo,charging curve, internal temp. and DC output ON/OFF)			
	CHARGER OK	The TTL signal out, Charger OK = H(4.5 ~ 5.5V) ; Charger failure or protection status =L(-0.5 ~ +0.5V)			
	BATTERY FULL SIGNAL	The TTL signal out, Battery full = H(4.5 ~ 5.5V) ; Charging = L(-0.5 ~ +0.5V)			
	REMOTE CONTROL	Short : Charger normal work Open : Charger stop charging			
	TEMPERATURE COMPENSATION	By external NTC			
	FAN SPEED CONTROL	Depends on internal temperature			
ENVIRON- MENT	WORK TEMP.	-30 ~ +70°C (Refer to "Derating Curve")			
	WORKING HUMIDITY	20 ~ 95% RH non-condensing			
	STORAGE TEMP., HUMIDITY	-40 ~ +85°C, 10 ~ 95% RH non-condensing			
	TEMP. COEFFICIENT	\pm 0.05%/°C (0 ~ 50°C)			
VIBRATION	10 ~ 500Hz, 2G 10min./1cycle, 60min. each along X, Y, Z axes				
OTHER	MTBF	273.7K hrs min. Telcordia SR-332(Bellcore) ; 83.4K hrs min. MIL-HDBK-217F (25°C)			
	DIMENSION	205*135*55mm (L*W*H)			
	PACKING	1.02Kg; 8pcs/10Kg/1.71CUFT			

NPB-450NFC系列

MODEL	NPB-450-12NFC	NPB-450-24NFC	NPB-450-48NFC	NPB-450-72NFC	
OUTPUT	BOOST CHARGE VOLTAGE (Vboost)(default)	14.4V	28.8V	57.6V	72V
	FLOAT CHARGE VOLTAGE (Vfloat)(default)	13.8V	27.6V	55.2V	69V
	CHARGE VOLTAGE RANGE Note.3	10.5 ~ 21V	21 ~ 42V	42 ~ 80V	54 ~ 100V
	MAX. OUTPUT CURRENT (CC) Note.4	25A	13.5A	6.8A	5.5A
	MAX. POWER Note.4	420W	453.6W	456.96W	462W
	RECOMMENDED BATTERY CAPACITY (AMP HOURS) Note.5	90 ~ 300AH	45 ~ 155AH	24 ~ 80AH	19 ~ 64AH
	LEAKAGE CURRENT FROM BATTERY (Typ.)	<1mA			
INPUT	VOLTAGE RANGE Note.6	90 ~ 264VAC	127 ~ 370VDC		
	FREQUENCY RANGE	47 ~ 63Hz			
	POWER FACTOR (Typ.)	PF>0.98/115VAC, PF>0.95/230VAC at full load			
	EFFICIENCY (Typ.) Note.7	92%	93%	93%	93%
	AC CURRENT (Typ.)	4.5A/115VAC	2.2A/230VAC		
	INRUSH CURRENT (Typ.)	COLD START 50A at 230VAC			
	LEAKAGE CURRENT	<0.75mA/240VAC			
PROTECTION	SHORT CIRCUIT Note.8	Protection type : Constant current limiting, charger will shutdown after 5 sec, re-power on to recover			
	OVER VOLTAGE Note.9	21.5 ~ 26V	43 ~ 52V	82 ~ 100V	102 ~ 120V
	REVERSE POLARITY	Protected internal reverse detection, No damage, re-power on to recover after fault condition is removed			
	OVER TEMPERATURE	Shut down O/P voltage, recovers automatically after temperature goes down			
FUNCTION	CHARGING CURVE	2/3 stage charging can be selected through NFC			
	CHARGING PARAMETERS PROGRAMMABLE	Programmable: Constant current(CC), Tapper current(TC), Constant voltage(CV) and Float voltage(FV) can be set through SBP-001with computer or using NFC through APP Manual setting: 4 built-in charging curves adjustable via DIP S.W on panel, Please refer to function manual for more detail			
	AUTO RANGING CHARGING CURVE (Typ.)	Please refer to functin manual for more detail (page 10) Charging current adjustable 50~100% by via potentiometer on panel (Only for auto ranging mode)			
	CANBUS INTERFACE	CANBus 2.0B, Can control, Setting and monitoring(Vo,IO,charging curve, internal temp. and DC output ON/OFF)			
	NFC INTERFACE	Set up charging parameters easily via NFCinterface			
	CHARGER OK	The TTL signal out, Charger OK = H(4.5 ~ 5.5V) ; Charger failure or protection status =L(-0.5 ~ +0.5V)			
	BATTERY FULL SIGNAL	The TTL signal out, Battery full = H(4.5 ~ 5.5V) ; Charging = L(-0.5 ~ +0.5V)			
	REMOTE CONTROL	Short : Charger normal work Open : Charger stop charging			
	TEMPERATURE COMPENSATION	By external NTC			
	FAN SPEED CONTROL	Depends on internal temperature			
	ENVIRON- MENT	WORK TEMP.	-30 ~ +70? (Refer to "Derating Curve")		
WORKING HUMIDITY		20 ~ 95% RH non-condensing			
STORAGE TEMP., HUMIDITY		-40 ~ +85? , 10 ~ 95% RH non-condensing			
TEMP. COEFFICIENT		? 0.05%/? (0 ~ 50?)			
VIBRATION		10 ~ 500Hz, 2G 10min./1cycle, 60min. each along X, Y, Z axes			
OTHER	MTBF	821.0K hrs min. Telcordia SR-332 (Bellcore) ; 83.4K hrs min. MIL-HDBK-217F (25?)			
	DIMENSION	205*135*55mm (L*W*H)			
	PACKING	1.02Kg; 8pcs/ 10Kg / 1.71CUFT			

NPB-750系列

MODEL	NPB-750-12	NPB-750-24	NPB-750-48		
OUTPUT	BOOST CHARGE VOLTAGE (Vboost)(default)	14.4V	28.8V	57.6V	
	FLOAT CHARGE VOLTAGE (Vfloat)(default)	13.8V	27.6V	55.2V	
	CHARGE VOLTAGE RANGE Note.3	10.5 ~ 21V	21 ~ 42V	42 ~ 80V	
	MAX. OUTPUT CURRENT (CC) Note.4	43A	22.5A	11.3A	
	MAX. POWER Note.4	722.4W	756W	759.36W	
	RECOMMENDED BATTERY CAPACITY (AMP HOURS) Note.5	150 ~ 500AH	80 ~ 260AH	40 ~ 130AH	
	LEAKAGE CURRENT FROM BATTERY (Typ.)	<1mA			
INPUT	VOLTAGE RANGE Note.6	90 ~ 264VAC	127 ~ 370VDC		
	FREQUENCY RANGE	47 ~ 63Hz			
	POWER FACTOR (Typ.)	PF>0.98/115VAC, PF>0.95/230VAC at full load			
	EFFICIENCY (Typ.) Note.7	92%	93%	93%	
	AC CURRENT (Typ.)	8.7A/115VAC	4A/230VAC		
	INRUSH CURRENT (Typ.)	COLD START 50A at 230VAC			
	LEAKAGE CURRENT	<1mA/240VAC			
PROTECTION	SHORT CIRCUIT Note.8	Protection type : Constant current limiting, charger will shutdown after 5 sec, re-power on to recover			
	OVER VOLTAGE Note.9	21.5 ~ 26V	43 ~ 52V	82 ~ 100V	
	REVERSE POLARITY	Protected internal reverse detection, No damage, re-power on to recover after fault condition is removed			
	OVER TEMPERATURE	Shut down O/P voltage, recovers automatically after temperature goes down			
FUNCTION	CHARGING CURVE	2 or 3 stage selectable through DIP S.W on panel, or SBP-001 with computer			
	CHARGING PARAMETERS PROGRAMMABLE	Programmable: Constant current(CC), Tapper current(TC), Constant voltage(CV) and Float voltage(FV) can be set through SBP-001 with computer Manual setting: 4 built-in charging curves adjustable via DIP S.W on panel, Please refer to function manual for more detail			
	AUTO RANGING CHARGING CURVE (Typ.)	Please refer to functin manual for more detail (page 8) Charging current adjustable 50~100% by via potentiometer on panel (Only for auto ranging mode)			
	CANBUS INTERFACE	CANBus 2.0B, Can control, Setting and monitoring(Vo,lo,charging curve, internal temp. and DC output ON/OFF)			
	CHARGER OK	The TTL signal out, Charger OK = H(4.5 ~ 5.5V) ; Charger failure or protection status =L(-0.5 ~ +0.5V)			
	BATTERY FULL SIGNAL	The TTL signal out, Battery full = H(4.5 ~ 5.5V) ; Charging = L(-0.5 ~ +0.5V)			
	REMOTE CONTROL	Short : Charger normal work Open : Charger stop charging			
	TEMPERATURE COMPENSATION	By external NTC			
	FAN SPEED CONTROL	Depends on internal temperature			
	ENVIRON- MENT	WORK TEMP.	-30 ~ +70°C (Refer to "Derating Curve")		
		WORKING HUMIDITY	20 ~ 95% RH non-condensing		
STORAGE TEMP., HUMIDITY		-40 ~ +85°C, 10 ~ 95% RH non-condensing			
TEMP. COEFFICIENT		±0.05%/°C (0 ~ 50°C)			
VIBRATION		10 ~ 500Hz, 2G 10min./1cycle, 60min. each along X, Y, Z axes			
OTHER	MTBF	227.6K hrs min. Telcordia SR-332(Bellcore) ; 67.7K hrs min. MIL-HDBK-217F (25°C)			
	DIMENSION	230*158*67mm (L*W*H)			
	PACKING	1.84Kg; 4pcs/9Kg/1.63CUFT			

NPB-1200系列

MODEL	NPB-1200-12	NPB-1200-24	NPB-1200-48	
OUTPUT	BOOST CHARGE VOLTAGE (Vboost)(default)	14.4V	28.8V	57.6V
	FLOAT CHARGE VOLTAGE (Vfloat)(default)	13.8V	27.6V	55.2V
	CHARGE VOLTAGE RANGE Note.3	10.5 ~ 21V	21 ~ 42V	42 ~ 80V
	MAX. OUTPUT CURRENT (CC) Note.4	70A	36A	18A
	MAX. POWER Note.4	1176W	1209.6W	1209.6W
	RECOMMENDED BATTERY CAPACITY (AMP HOURS) Note.5	240 ~ 800AH	120 ~ 420AH	60 ~ 210AH
	LEAKAGE CURRENT FROM BATTERY (Typ.)	<1mA		
INPUT	VOLTAGE RANGE Note.6	90 ~ 264VAC	127 ~ 370VDC	
	FREQUENCY RANGE	47 ~ 63Hz		
	POWER FACTOR (Typ.)	PF>0.98/115VAC, PF>0.95/230VAC at full load		
	EFFICIENCY (Typ.) Note.7	92%	93%	94%
	AC CURRENT (Typ.)	12A/115VAC	6.5A/230VAC	
	INRUSH CURRENT (Typ.)	COLD START 50A at 230VAC		
	LEAKAGE CURRENT	<1mA/240VAC		
PROTECTION	SHORT CIRCUIT Note.8	Protection type : Constant current limiting, charger will shutdown after 5 sec, re-power on to recover		
	OVER VOLTAGE Note.9	21.5 ~ 26V	43 ~ 52V	82 ~ 100V
	REVERSE POLARITY	Protected internal reverse detection, No damage, re-power on to recover after fault condition is removed		
	OVER TEMPERATURE	Shut down O/P voltage, recovers automatically after temperature goes down		
FUNCTION	CHARGING CURVE	2 or 3 stage selectable through DIP S.W on panel, or SBP-001 with computer		
	CHARGING PARAMETERS PROGRAMMABLE	Programmable: Constant current(CC), Tapper current(TC), Constant voltage(CV) and Float voltage(FV) can be set through SBP-001 with computer Manual setting: 4 built-in charging curves adjustable via DIP S.W on panel, Please refer to function manual for more detail		
	AUTO RANGING CHARGING CURVE (Typ.)	Please refer to functin manual for more detail (page 8) Charging current adjustable 50~100% by via potentiometer on panel (Only for auto ranging mode)		
	CANBUS INTERFACE	CANBus 2.0B, Can control, Setting and monitoring(Vo, Io, charging curve, internal temp. and DC output ON/OFF)		
	CHARGER OK	The TTL signal out, Charger OK = H(4.5 ~ 5.5V); Charger failure or protection status =L(-0.5 ~ +0.5V)		
	BATTERY FULL SIGNAL	The TTL signal out, Battery full = H(4.5 ~ 5.5V); Charging = L(-0.5 ~ +0.5V)		
	REMOTE CONTROL	Short : Charger normal work Open : Charger stop charging		
	TEMPERATURE COMPENSATION	By external NTC		
	FAN SPEED CONTROL	Depends on internal temperature		
	ENVIRONMENT	WORK TEMP.	-30 ~ +70°C (Refer to "Derating Curve")	
WORKING HUMIDITY		20 ~ 95% RH non-condensing		
STORAGE TEMP., HUMIDITY		-40 ~ +85°C, 10 ~ 95% RH non-condensing		
TEMP. COEFFICIENT		±0.05%/°C (0 ~ 50°C)		
VIBRATION		10 ~ 500Hz, 2G 10min./1cycle, 60min. each along X, Y, Z axes		
OTHER	MTBF	172.5K hrs min. Telcordia SR-332(Bellcore); 47.5K hrs min.	MIL-HDBK-217F (25°C)	
	DIMENSION	250*158*67mm (L*W*H)		
	PACKING	1.93Kg; 4pcs/10Kg/1.72CUFT		

NPB-1700系列

MODEL	NPB-1700-12	NPB-1700-24	NPB-1700-48	
OUTPUT	BOOST CHARGE VOLTAGE (Vboost)(default)	14.4V	28.8V	57.6V
	FLOAT CHARGE VOLTAGE (Vfloat)(default)	13.8V	27.6V	55.2V
	CHARGE VOLTAGE RANGE Note.3	10.5 ~ 21V	21 ~ 42V	42 ~ 80V
	MAX. OUTPUT CURRENT (CC) Note.4	85A	50A	25A
	MAX. POWER Note.4	1428W	1680W	1680W
	RECOMMENDED BATTERY CAPACITY (AMP HOURS) Note.5	300 ~ 1000AH	200 ~ 640AH	100 ~ 330AH
	LEAKAGE CURRENT FROM BATTERY (Typ.)	<1mA		
INPUT	VOLTAGE RANGE Note.6	90 ~ 264VAC	127 ~ 370VDC	
	FREQUENCY RANGE	47 ~ 63Hz		
	POWER FACTOR (Typ.)	PF>0.98/115VAC, PF>0.95/230VAC at full load		
	EFFICIENCY (Typ.) Note.7	92%	93%	94%
	AC CURRENT (Typ.)	14.8A/115VAC	9.3A/230VAC	
	INRUSH CURRENT (Typ.)	COLD START 50A at 230VAC		
	LEAKAGE CURRENT	<0.75mA/240VAC(60335-1/2-29), <1.5mA Peak/240VAC(62368-1)		
PROTECTION	SHORT CIRCUIT Note.8	Protection type : Constant current limiting, charger will shutdown after 5 sec, re-power on to recover		
	OVER VOLTAGE Note.9	21.5 ~ 26V	43 ~ 52V	82 ~ 100V
	REVERSE POLARITY	Protected internal reverse detection, No damage, re-power on to recover after fault condition is removed		
	OVER TEMPERATURE	Shut down O/P voltage, recovers automatically after temperature goes down		
FUNCTION	CHARGING CURVE	2 or 3 stage selectable through DIP S.W on panel, or SBP-001 with computer		
	CHARGING PARAMETERS PROGRAMMABLE	Programmable: Constant current(CC), Tapper current(TC), Constant voltage(CV) and Float voltage(FV) can be set through SBP-001 with computer Manual setting: 4 built-in charging curves adjustable via DIP S.W on panel, Please refer to function manual for more detail		
	AUTO RANGING CHARGING CURVE (Typ.)	Please refer to functin manual for more detail (page 8) Charging current adjustable 50~100% by via potentiometer on panel (Only for auto ranging mode)		
	CANBUS INTERFACE	CANBus 2.0B, Can control, Setting and monitoring(Vo, Io, charging curve, internal temp. and DC output ON/OFF)		
	CHARGER OK	The TTL signal out, Charger OK = H(4.5 ~ 5.5V); Charger failure or protection status =L(-0.5 ~ +0.5V)		
	BATTERY FULL SIGNAL	The TTL signal out, Battery full = H(4.5 ~ 5.5V); Charging = L(-0.5 ~ +0.5V)		
	REMOTE CONTROL	Short : Charger normal work Open : Charger stop charging		
	TEMPERATURE COMPENSATION	By external NTC		
	FAN SPEED CONTROL	Depends on internal temperature		
	ENVIRONMENT	WORK TEMP.	-30 ~ +70°C (Refer to "Derating Curve")	
WORKING HUMIDITY		20 ~ 95% RH non-condensing		
STORAGE TEMP., HUMIDITY		-40 ~ +85°C, 10 ~ 95% RH non-condensing		
TEMP. COEFFICIENT		±0.05%/°C (0 ~ 50°C)		
VIBRATION		10 ~ 500Hz, 2G 10min./1cycle, 60min. each along X, Y, Z axes		
OTHER	MTBF	190.0K hrs min. Telcordia SR-332(Bellcore); 45.1K hrs min.	MIL-HDBK-217F (25°C)	
	DIMENSION	307*184*76.35mm (L*W*H)		
	PACKING	2.93Kg; 4cs/14Kg/2.58CUFT		

NPP-450系列-充電器模式(Default)

MODEL		NPP-450-12	NPP-450-24	NPP-450-48	NPP-450-72
OUTPUT	BOOST CHARGE VOLTAGE (Vboost)(default)	14.4V	28.8V	57.6V	72V
	FLOAT CHARGE VOLTAGE (Vfloat)(default)	13.8V	27.6V	55.2V	69V
	VOLTAGE ADJUSTABLE RANGE	10.5 ~ 21V	21 ~ 42V	42 ~ 80V	54 ~ 100V
		By built-in potentiometer			
	MAX. OUTPUT CURRENT(CC)	25A	13.5A	6.8A	5.5A
	CURRENT ADJUSTABLE RANGE	12.5 ~ 25A	6.75 ~ 13.5A	3.4 ~ 6.8A	2.75 ~ 5.5A
		Note.3 By built-in potentiometer			
	MAX. POWER	420W	453.6W	456.96W	462W
RECOMMENDED BATTERY CAPACITY (AMP HOURS) Note.4	90 ~ 300AH	45 ~ 155AH	24 ~ 80AH	19 ~ 64AH	
INPUT	VOLTAGE RANGE Note.5	90 ~ 264VAC	127 ~ 370VDC		
	FREQUENCY RANGE	47 ~ 63Hz			
	POWER FACTOR (Typ.)	PF>0.98/115VAC, PF>0.95/230VAC at full load			
	EFFICIENCY (Typ.) Note.6	92%	93%	93%	93%
	AC CURRENT (Typ.)	4.5A/115VAC	2.2A/230VAC		
	INRUSH CURRENT (Typ.)	COLD START 50A at 230VAC			
PROTECTION	SHORT CIRCUIT Note.7	Protection type : Constant current limiting, charger will shutdown after 5 sec. re-power on to recover			
	OVER VOLTAGE	21.5 ~ 26V	43 ~ 52V	82 ~ 100V	102 ~ 120V
	OVER TEMPERATURE	Protection type : Shut down and latch off o/p voltage, re-power on to recover Shut down O/P voltage, recovers automatically after temperature goes down			
FUNCTION	CHARGING STAGE	3 stage only			
	CHARGER OK SIGNAL	The TTL signal out, Charger OK = H(4.5 ~ 5.5V) ; Charger failure or protection status = L(-0.5 ~ +0.5V)			
	BATTERY FULL SIGNAL	The TTL signal out, Battery full = H(4.5 ~ 5.5V) ; Charging = L(-0.5 ~ +0.5V)			
	REMOTE CONTROL	Open : Charger stop charging Short : Charger normal work			
	FAN SPEED CONTROL	Depends on internal temperature			
ENVIRON- MENT	WORK TEMP.	-30 ~ +70°C (Refer to "Derating Curve")			
	WORKING HUMIDITY	20 ~ 95% RH non-condensing			
	STORAGE TEMP., HUMIDITY	-40 ~ +85°C, 10 ~ 95% RH non-condensing			
	TEMP. COEFFICIENT	±0.05%/°C (0 ~ 50°C)			
	VIBRATION	10 ~ 500Hz, 2G 10min./1cycle, 60min. each along X, Y, Z axes			
OTHER	MTBF	352.3K hrs min. Telcordia SR-332(Bellcore) ; 118.5K hrs min. MIL-HDBK-217F (25°C)			
	DIMENSION	205*135*55mm (L*W*H)			
	PACKING	1.02Kg; 8pcs/10Kg/1.71CUFT			

NPP-450系列-電源供應器模式

MODEL		NPP-450-12	NPP-450-24	NPP-450-48	NPP-450-72
OUTPUT	DC VOLTAGE	14.4V	28.8V	57.6V	72V
	VOLTAGE ADJUSTABLE RANGE	10.5 ~ 21V	21 ~ 42V	42 ~ 80V	54 ~ 100V
		By built-in potentiometer			
	CURRENT ADJUSTABLE RANGE	12.5 ~ 25A	6.75 ~ 13.5A	3.4 ~ 6.8A	2.75 ~ 5.5A
	RATED CURRENT	25A	13.5A	6.8A	5.5A
	RATED POWER	420W	453.6W	457W	462W
	RIPPLE & NOISE (max.)	180mVp-p	300mVp-p	480mVp-p	600mVp-p
	VOLTAGE TOLERANCE	±1.0%	±1.0%	±1.0%	±1.0%
	LINE REGULATION	±0.5%	±0.5%	±0.5%	±0.5%
	LOAD REGULATION	±1.0%	±1.0%	±0.5%	±0.5%
	SETUP, RISE TIME	1800ms, 60ms/230VAC at full load			
	HOLD UP TIME (Typ.)	16ms/230VAC at 75% load 10ms/230VAC at full load			
	INPUT	VOLTAGE RANGE Note.3	90 ~ 264VAC	127 ~ 370VDC	
FREQUENCY RANGE		47 ~ 63Hz			
POWER FACTOR (Typ.)		PF>0.98/115VAC, PF>0.95/230VAC at full load			
EFFICIENCY (Typ.)		92%	93%	93%	93%
AC CURRENT (Typ.)		4.5A/115VAC	2.2A/230VAC		
INRUSH CURRENT (Typ.)		COLD START 50A at 230VAC			
PROTECTION	OVERLOAD	105 ~ 115% rated output power Protection type : Constant current limiting, unit will shutdown after 5 sec, re-power on to recover			
	SHORT CIRCUIT	Protection type : Constant current limiting, unit will shutdown after 5 sec, re-power on to recover			
	OVER VOLTAGE	21.5 ~ 26V	43 ~ 52V	82 ~ 100V	102 ~ 120V
	OVER TEMPERATURE	Protection type : Shut down and latch off o/p voltage, re-power on to recover Shut down O/P voltage, recovers automatically after temperature goes down			
FUNCTION	REMOTE CONTROL	Open : Power OFF Short : Power ON			
	DC OK	The TTL signal out, DC OK = H(4.5 ~ 5.5V) ; Power supply failure or protection = L(-0.5 ~ +0.5V)			
	FAN SPEED CONTROL	Depends on internal temperature			
ENVIRON- MENT	WORK TEMP.	-30 ~ +70°C (Refer to "Derating Curve")			
	WORKING HUMIDITY	20 ~ 95% RH non-condensing			
	STORAGE TEMP., HUMIDITY	-40 ~ +85°C, 10 ~ 95% RH non-condensing			
	TEMP. COEFFICIENT	±0.05%/°C (0 ~ 50°C)			
	VIBRATION	10 ~ 500Hz, 2G 10min./1cycle, 60min. each along X, Y, Z axes			
OTHER	MTBF	352.3K hrs min. Telcordia SR-332(Bellcore) ; 118.5K hrs min. MIL-HDBK-217F (25°C)			
	DIMENSION	205*135*55mm (L*W*H)			
	PACKING	1.02Kg; 8pcs/10Kg/1.71CUFT			

NPP-750系列-充電器模式(Default)

MODEL	NPP-750-12	NPP-750-24	NPP-750-48	
OUTPUT	BOOST CHARGE VOLTAGE (Vboost)(default)	14.4V	28.8V	57.6V
	FLOAT CHARGE VOLTAGE (Vfloat)(default)	13.8V	27.6V	55.2V
	VOLTAGE ADJUSTABLE RANGE	10.5 ~ 21V	21 ~ 42V	42 ~ 80V
		By built-in potentiometer		
	MAX. OUTPUT CURRENT(CC)	43A	22.5A	11.3A
	CURRENT ADJUSTABLE RANGE	21.5 ~ 43A	11.25 ~ 22.5A	5.65 ~ 11.3A
		Note.3 By built-in potentiometer		
	MAX. POWER	722.4W	756W	759.36W
RECOMMENDED BATTERY CAPACITY (AMP HOURS) Note.4	150 ~ 500AH	80 ~ 260AH	40 ~ 130AH	
INPUT	VOLTAGE RANGE Note.5	90 ~ 264VAC	127 ~ 370VDC	
	FREQUENCY RANGE	47 ~ 63Hz		
	POWER FACTOR (Typ.)	PF>0.98/115VAC, PF>0.95/230VAC at full load		
	EFFICIENCY (Typ.) Note.6	92%	93%	93%
	AC CURRENT (Typ.)	8.7A/115VAC	4A/230VAC	
	INRUSH CURRENT (Typ.)	COLD START 50A at 230VAC		
PROTECTION	SHORT CIRCUIT Note.7	Protection type : Constant current limiting, charger will shutdown after 5 sec. re-power on to recover		
	OVER VOLTAGE	21.5 ~ 26V	43 ~ 52V	82 ~ 100V
	OVER TEMPERATURE	Shut down O/P voltage, recovers automatically after temperature goes down		
FUNCTION	CHARGING STAGE	3 stage only		
	CHARGER OK SIGNAL	The TTL signal out, Charger OK = H(4.5 ~ 5.5V) ; Charger failure or protection status =L(-0.5 ~ +0.5V)		
	BATTERY FULL SIGNAL	The TTL signal out, Battery full = H(4.5 ~ 5.5V) ; Charging = L(-0.5 ~ +0.5V)		
	REMOTE CONTROL	Open : Charger stop charging Short : Charger normal work		
	FAN SPEED CONTROL	Depends on internal temperature		
ENVIRON- MENT	WORK TEMP.	-30 ~ +70°C (Refer to "Derating Curve")		
	WORKING HUMIDITY	20 ~ 95% RH non-condensing		
	STORAGE TEMP., HUMIDITY	-40 ~ +85°C, 10 ~ 95% RH non-condensing		
	TEMP. COEFFICIENT	±0.05%/°C (0 ~ 50°C)		
	VIBRATION	10 ~ 500Hz, 2G 10min./1cycle, 60min. each along X, Y, Z axes		
OTHER	MTBF	294.5K hrs min. Telcordia SR-332(Bellcore) ; 95.7K hrs min. MIL-HDBK-217F (25°C)		
	DIMENSION	230*158*67mm (L*W*H)		
	PACKING	1.84Kg; 4pcs/9Kg/1.63CUFT		

NPP-750系列-電源供應器模式

MODEL	NPP-750-12	NPP-750-24	NPP-750-48	
OUTPUT	DC VOLTAGE	14.4V	28.8V	57.6V
	VOLTAGE ADJUSTABLE RANGE	10.5 ~ 21V	21 ~ 42V	42 ~ 80V
		By built-in potentiometer		
	CURRENT ADJUSTABLE RANGE	21.5 ~ 43V	11.25 ~ 22.5V	5.65 ~ 11.3V
	RATED CURRENT	43A	22.5A	11.3A
	RATED POWER	722.4W	756W	759.36W
	RIPPLE & NOISE (max.)	180mVp-p	300mVp-p	480mVp-p
	VOLTAGE TOLERANCE	±1.0%	±1.0%	±1.0%
	LINE REGULATION	±0.5%	±0.5%	±0.5%
	LOAD REGULATION	±1.0%	±1.0%	±0.5%
	SETUP, RISE TIME	1800ms, 60ms/230VAC at full load		
	HOLD UP TIME (Typ.)	16ms/230VAC at 75% load	10ms/230VAC at full load	
	INPUT	VOLTAGE RANGE Note.3	90 ~ 264VAC	127 ~ 370VDC
FREQUENCY RANGE		47 ~ 63Hz		
POWER FACTOR (Typ.)		PF>0.98/115VAC, PF>0.95/230VAC at full load		
EFFICIENCY (Typ.)		92%	93%	93%
AC CURRENT (Typ.)		8.7A/115VAC	4A/230VAC	
INRUSH CURRENT (Typ.)		COLD START 50A at 230VAC		
PROTECTION	OVERLOAD	105 ~ 115% rated output power Protection type : Constant current limiting, unit will shutdown after 5 sec, re-power on to recover		
	SHORT CIRCUIT	Protection type : Constant current limiting, unit will shutdown after 5 sec, re-power on to recover		
	OVER VOLTAGE	21.5 ~ 26V	43 ~ 52V	82 ~ 100V
	OVER TEMPERATURE	Shut down O/P voltage, recovers automatically after temperature goes down		
FUNCTION	REMOTE CONTROL	Open : Power OFF Short : Power ON		
	DC OK	The TTL signal out, DC OK = H(4.5 ~ 5.5V) ; Power supply failure or protection = L(-0.5 ~ +0.5V)		
	FAN SPEED CONTROL	Depends on internal temperature		
ENVIRON- MENT	WORK TEMP.	-30 ~ +70°C (Refer to "Derating Curve")		
	WORKING HUMIDITY	20 ~ 95% RH non-condensing		
	STORAGE TEMP., HUMIDITY	-40 ~ +85°C, 10 ~ 95% RH non-condensing		
	TEMP. COEFFICIENT	±0.05%/°C (0 ~ 50°C)		
	VIBRATION	10 ~ 500Hz, 2G 10min./1cycle, 60min. each along X, Y, Z axes		
OTHER	MTBF	294.5K hrs min. Telcordia SR-332(Bellcore) ; 95.7K hrs min. MIL-HDBK-217F (25°C)		
	DIMENSION	230*158*67mm (L*W*H)		
	PACKING	1.84Kg; 4pcs/9Kg/1.63CUFT		

NPP-1200系列-充電器模式(Default)

MODEL	NPP-1200-12	NPP-1200-24	NPP-1200-48	
OUTPUT	BOOST CHARGE VOLTAGE (Vboost)(default)	14.4V	28.8V	57.6V
	FLOAT CHARGE VOLTAGE (Vfloat)(default)	13.8V	27.6V	55.2V
	VOLTAGE ADJUSTABLE RANGE	10.5 ~ 21V	21 ~ 42V	42 ~ 80V
		By built-in potentiometer		
	MAX. OUTPUT CURRENT(CC)	70A	36A	18A
	CURRENT ADJUSTABLE RANGE	35 ~ 70A	18 ~ 36A	9 ~ 18A
		Note.3 By built-in potentiometer		
	MAX. POWER	1176W	1209.6W	1209.6W
RECOMMENDED BATTERY CAPACITY (AMP HOURS) Note.4	240 ~ 800AH	120 ~ 420AH	60 ~ 210AH	
INPUT	VOLTAGE RANGE Note.5	90 ~ 264VAC	127 ~ 370VDC	
	FREQUENCY RANGE	47 ~ 63Hz		
	POWER FACTOR (Typ.)	PF>0.98/115VAC, PF>0.95/230VAC at full load		
	EFFICIENCY (Typ.) Note.6	92%	93%	94%
	AC CURRENT (Typ.)	12A/115VAC	6.5A/230VAC	
	INRUSH CURRENT (Typ.)	COLD START 50A at 230VAC		
PROTECTION	SHORT CIRCUIT Note.7	Protection type : Constant current limiting, charger will shutdown after 5 sec. re-power on to recover		
	OVER VOLTAGE	21.5 ~ 26V	43 ~ 52V	82 ~ 100V
	OVER TEMPERATURE	Shut down O/P voltage, recovers automatically after temperature goes down		
FUNCTION	CHARGING STAGE	3 stage only		
	CHARGER OK SIGNAL	The TTL signal out, Charger OK = H(4.5 ~ 5.5V); Charger failure or protection status = L(-0.5 ~ +0.5V)		
	BATTERY FULL SIGNAL	The TTL signal out, Battery full = H(4.5 ~ 5.5V); Charging = L(-0.5 ~ +0.5V)		
	REMOTE CONTROL	Open : Charger stop charging Short : Charger normal work		
	FAN SPEED CONTROL	Depends on internal temperature		
ENVIRON- MENT	WORK TEMP.	-30 ~ +70°C (Refer to "Derating Curve")		
	WORKING HUMIDITY	20 ~ 95% RH non-condensing		
	STORAGE TEMP., HUMIDITY	-40 ~ +85°C, 10 ~ 95% RH non-condensing		
	TEMP. COEFFICIENT	±0.05%/°C (0 ~ 50°C)		
	VIBRATION	10 ~ 500Hz, 2G 10min./1cycle, 60min. each along X, Y, Z axes		
OTHER	MTBF	208.4K hrs min. Telcordia SR-332(Bellcore); 63.6K hrs min. MIL-HDBK-217F (25°C)		
	DIMENSION	250*158*67mm (L*W*H)		
	PACKING	1.93Kg; 4pcs/10Kg/1.72CUFT		

NPP-1200系列-電源供應器模式

MODEL	NPP-1200-12	NPP-1200-24	NPP-1200-48	
OUTPUT	DC VOLTAGE	14.4V	28.8V	57.6V
	VOLTAGE ADJUSTABLE RANGE	10.5 ~ 21V	21 ~ 42V	42 ~ 80V
		By built-in potentiometer		
	CURRENT ADJUSTABLE RANGE	35 ~ 70V	18 ~ 36V	9 ~ 18V
	RATED CURRENT	70A	36A	18A
	RATED POWER	1176W	1209.6W	1209.6W
	RIPPLE & NOISE (max.)	180mVp-p	300mVp-p	480mVp-p
	VOLTAGE TOLERANCE	±1.0%	±1.0%	±1.0%
	LINE REGULATION	±0.5%	±0.5%	±0.5%
	LOAD REGULATION	±1.0%	±1.0%	±0.5%
	SETUP, RISE TIME	1800ms, 60ms/230VAC at full load		
	HOLD UP TIME (Typ.)	16ms/230VAC at 75% load	10ms/230VAC at full load	
	INPUT	VOLTAGE RANGE Note.3	90 ~ 264VAC	127 ~ 370VDC
FREQUENCY RANGE		47 ~ 63Hz		
POWER FACTOR (Typ.)		PF>0.98/115VAC, PF>0.95/230VAC at full load		
EFFICIENCY (Typ.)		92%	93%	94%
AC CURRENT (Typ.)		12A/115VAC	6.5A/230VAC	
INRUSH CURRENT (Typ.)		COLD START 50A at 230VAC		
PROTECTION	OVERLOAD	105 ~ 115% rated output power Protection type : Constant current limiting, unit will shutdown after 5 sec, re-power on to recover		
	SHORT CIRCUIT	Protection type : Constant current limiting, unit will shutdown after 5 sec, re-power on to recover		
	OVER VOLTAGE	21.5 ~ 26V	43 ~ 52V	82 ~ 100V
	OVER TEMPERATURE	Shut down O/P voltage, recovers automatically after temperature goes down		
FUNCTION	REMOTE CONTROL	Open : Power OFF Short : Power ON		
	DC OK	The TTL signal out, DC OK = H(4.5 ~ 5.5V); Power supply failure or protection = L(-0.5 ~ +0.5V)		
	FAN SPEED CONTROL	Depends on internal temperature		
ENVIRON- MENT	WORK TEMP.	-30 ~ +70°C (Refer to "Derating Curve")		
	WORKING HUMIDITY	20 ~ 95% RH non-condensing		
	STORAGE TEMP., HUMIDITY	-40 ~ +85°C, 10 ~ 95% RH non-condensing		
	TEMP. COEFFICIENT	±0.05%/°C (0 ~ 50°C)		
	VIBRATION	10 ~ 500Hz, 2G 10min./1cycle, 60min. each along X, Y, Z axes		
OTHER	MTBF	208.4K hrs min. Telcordia SR-332(Bellcore); 63.6K hrs min. MIL-HDBK-217F (25°C)		
	DIMENSION	250*158*67mm (L*W*H)		
	PACKING	1.93Kg; 4pcs/10Kg/1.72CUFT		

NPP-1700系列-充電器模式(Default)



MODEL	NPP-1700-12	NPP-1700-24	NPP-1700-48	
OUTPUT	BOOST CHARGE VOLTAGE (Vboost)(default)	14.4V	28.8V	57.6V
	FLOAT CHARGE VOLTAGE (Vfloat)(default)	13.8V	27.6V	55.2V
	VOLTAGE ADJUSTABLE RANGE	10.5 ~ 21V	21 ~ 42V	42 ~ 80V
		By built-in potentiometer		
	MAX. OUTPUT CURRENT(CC)	85A	50A	25A
	CURRENT ADJUSTABLE RANGE	42.5 ~ 85A	25 ~ 50A	12.5 ~ 2.5A
		Note.3 By built-in potentiometer		
	MAX. POWER	1428W	1680W	1680W
RECOMMENDED BATTERY CAPACITY (AMP HOURS) Note.4	300 ~ 1000AH	200 ~ 640AH	100 ~ 330AH	
INPUT	VOLTAGE RANGE Note.5	90 ~ 264VAC	127 ~ 370VDC	
	FREQUENCY RANGE	47 ~ 63Hz		
	POWER FACTOR (Typ.)	PF>0.98/115VAC, PF>0.95/230VAC at full load		
	EFFICIENCY (Typ.) Note.6	92%	93%	94%
	AC CURRENT (Typ.)	14.8A/115VAC	9.3A/230VAC	
	INRUSH CURRENT (Typ.)	COLD START 50A at 230VAC		
	LEAKAGE CURRENT	<0.75mA/240VAC(60335-1/2-29), <1.5mA Peak/240VAC(62368-1)		
PROTECTION	SHORT CIRCUIT Note.7	Protection type : Constant current limiting, charger will shutdown after 5 sec, re-power on to recover		
	OVER VOLTAGE	21.5 ~ 26V	43 ~ 52V	82 ~ 100V
	OVER TEMPERATURE	Shut down O/P voltage, recovers automatically after temperature goes down		
FUNCTION	CHARGING STAGE	3 stage only		
	CHARGER OK SIGNAL	The TTL signal out, Charger OK = H(4.5 ~ 5.5V); Charger failure or protection status = L(-0.5 ~ +0.5V)		
	BATTERY FULL SIGNAL	The TTL signal out, Battery full = H(4.5 ~ 5.5V); Charging = L(-0.5 ~ +0.5V)		
	REMOTE CONTROL	Open : Charger stop charging Short : Charger normal work		
	FAN SPEED CONTROL	Depends on internal temperature		
ENVIRONMENT	WORK TEMP.	-30 ~ +70°C (Refer to "Derating Curve")		
	WORKING HUMIDITY	20 ~ 95% RH non-condensing		
	STORAGE TEMP., HUMIDITY	-40 ~ +85°C, 10 ~ 95% RH non-condensing		
	TEMP. COEFFICIENT	±0.05%/°C (0 ~ 50°C)		
	VIBRATION	10 ~ 500Hz, 2G 10min./1cycle, 60min. each along X, Y, Z axes		
OTHER	MTBF	192.5K hrs min.	Telcordia SR-332(Bellcore); 58.5K hrs min.	MIL-HDBK-217F (25°C)
	DIMENSION	307*184*76.35mm (L*W*H)		
	PACKING	2.96Kg; 4pcs/14Kg/2.58CUFT		

NPP-1700系列-電源供應器模式

MODEL	NPP-1700-12	NPP-1700-24	NPP-1700-48	
OUTPUT	DC VOLTAGE	14.4V	28.8V	57.6V
	VOLTAGE ADJUSTABLE RANGE	10.5 ~ 21V	21 ~ 42V	42 ~ 80V
		By built-in potentiometer		
	CURRENT ADJUSTABLE RANGE	42.5 ~ 85V	25 ~ 50V	12.5 ~ 25V
	RATED CURRENT	85A	50A	25A
	RATED POWER	1428W	1680W	1680W
	RIPPLE & NOISE (max.)	180mVp-p	300mVp-p	480mVp-p
	VOLTAGE TOLERANCE	±2.0%	±1.0%	±1.0%
	LINE REGULATION	±0.5%	±0.5%	±0.5%
	LOAD REGULATION	±2.0%	±1.0%	±0.5%
	SETUP, RISE TIME	1800ms, 60ms/230VAC at full load		
	HOLD UP TIME (Typ.)	16ms/230VAC at 75% load 10ms/230VAC at full load		
	INPUT	VOLTAGE RANGE Note.3	90 ~ 264VAC	127 ~ 370VDC
FREQUENCY RANGE		47 ~ 63Hz		
POWER FACTOR (Typ.)		PF>0.98/115VAC, PF>0.95/230VAC at full load		
EFFICIENCY (Typ.)		92%	93%	94%
AC CURRENT (Typ.)		14.8A/115VAC	9.3A/230VAC	
INRUSH CURRENT (Typ.)		COLD START 50A at 230VAC		
LEAKAGE CURRENT		<0.75mA/240VAC		
PROTECTION	OVERLOAD	105 ~ 115% rated output power Protection type : Constant current limiting, unit will shutdown after 5 sec, re-power on to recover		
	SHORT CIRCUIT	Protection type : Constant current limiting, unit will shutdown after 5 sec, re-power on to recover		
	OVER VOLTAGE	21.5 ~ 26V	43 ~ 52V	82 ~ 100V
	OVER TEMPERATURE	Shut down O/P voltage, recovers automatically after temperature goes down		
FUNCTION	REMOTE CONTROL	Open : Power OFF Short : Power ON		
	DC OK	The TTL signal out, DC OK = H(4.5 ~ 5.5V); Power supply failure or protection = L(-0.5 ~ +0.5V)		
	FAN SPEED CONTROL	Depends on internal temperature		
ENVIRONMENT	WORK TEMP.	-30 ~ +70°C (Refer to "Derating Curve")		
	WORKING HUMIDITY	20 ~ 95% RH non-condensing		
	STORAGE TEMP., HUMIDITY	-40 ~ +85°C, 10 ~ 95% RH non-condensing		
	TEMP. COEFFICIENT	±0.05%/°C (0 ~ 50°C)		
	VIBRATION	10 ~ 500Hz, 2G 10min./1cycle, 60min. each along X, Y, Z axes		
OTHER	MTBF	192.5K hrs min.	Telcordia SR-332(Bellcore); 58.5K hrs min.	MIL-HDBK-217F (25°C)
	DIMENSION	307*184*76.35mm (L*W*H)		
	PACKING	2.96Kg; 4pcs/14Kg/2.58CUFT		

*詳細Note.之資訊，請參考明緯官網規格書

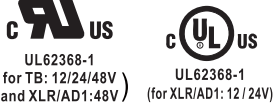
2.4 安規一覽表

Model	Safety
NPB-120	 IEC62368-1 IEC60335-1/2-29 BS EN/EN62368-1 BS EN/EN60335-1/2-29 TPTC004
NPB-360	 UL62368-1 (for TB: 12/24/48V and XLR/AD1:48V) UL62368-1 (for XLR/AD1: 12/24V)
NPB-240	 IEC62368-1 IEC60335-1/2-29 BS EN/EN62368-1 BS EN/EN60335-1/2-29 TPTC004
NPB/NPP-450	
NPB/NPP-750	
NPB/NPP-1200	
NPB/NPP-1700	
NPB-450NFC	 UL62368-1 BS EN/EN62368-1

注:对于EN60335-1/2-29的说明

- 本產品是內置電池充電器，計畫安裝在大篷車和其他類似的車輛內使用。本產品至少可以供1節可充電鉛酸或鋰離子電池或1個電池組充電，當給更多個可充電鉛酸或鋰離子電池或電池組充電時，應參考本手冊推薦的容量，其容量建議不超過本手冊推薦的最大電池容量。禁止給不可充電的電池充電。
- 優先連接未連接底盤的電池端。其次連接於底盤，遠離電池和燃油管線。然後將電池充電器連接到電源。
- 充電完成後，斷開電池充電器與電源的連接。然後拆卸底盤連接，再拆卸電池連接。
- 與供電幹線的連接應符合國家配線。
- 若無他人監督或指導，身體、感官、智力能力下降或缺乏經驗和常識的人（包括兒童）不可使用該設備。
- 監督兒童不可玩耍此設備。
- 設備與電源的連接，以及各分離元件的互連。
- 需要確保設備安裝後能夠斷開電源連接。

2.5 減額曲線

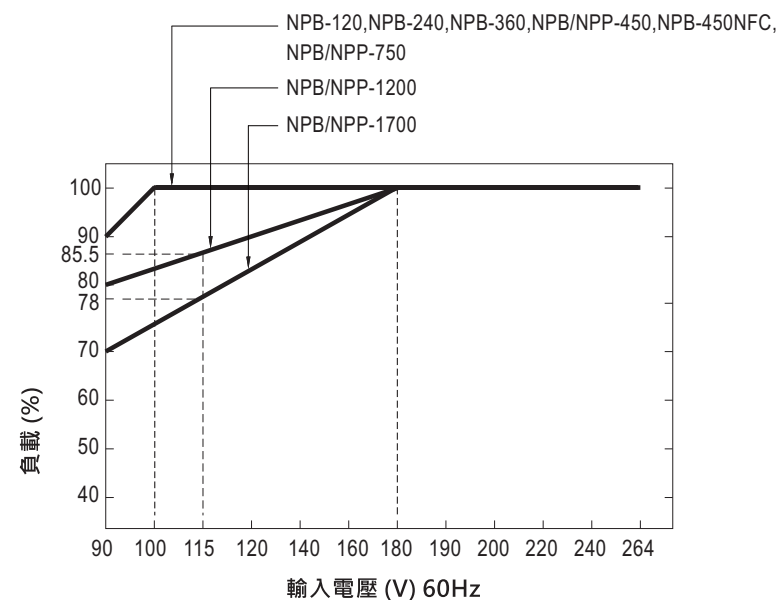
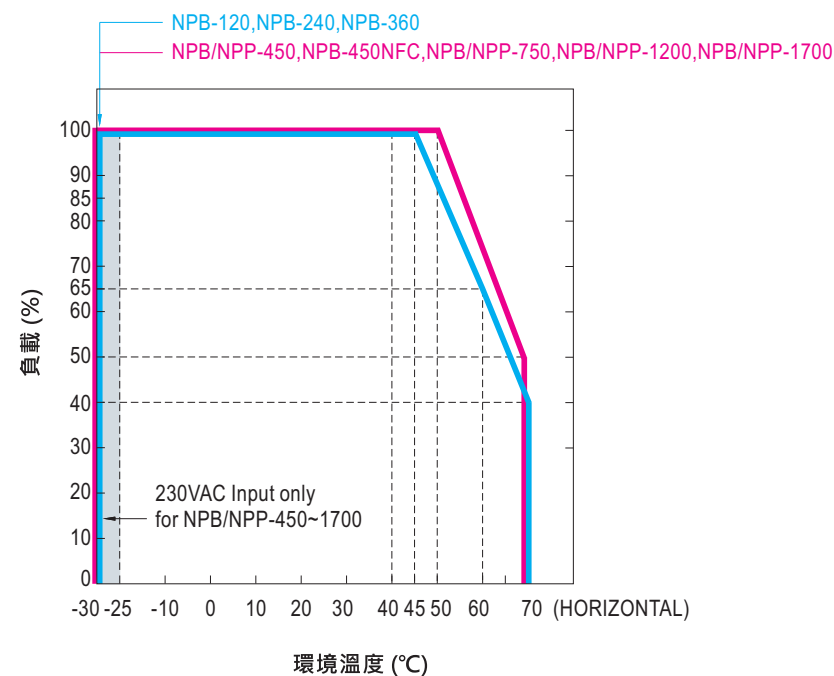

2.6 產品機構圖

NPB-120/240/360機構尺寸

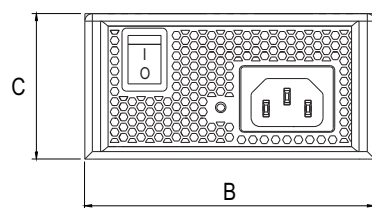
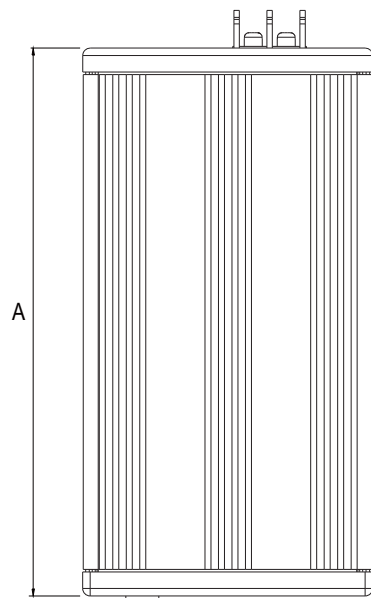

Model	A	B	C
NPB-120	180	96	49
NPB-240	180	96	49
NPB-360	180	96	49

單位:mm

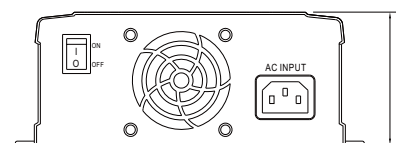
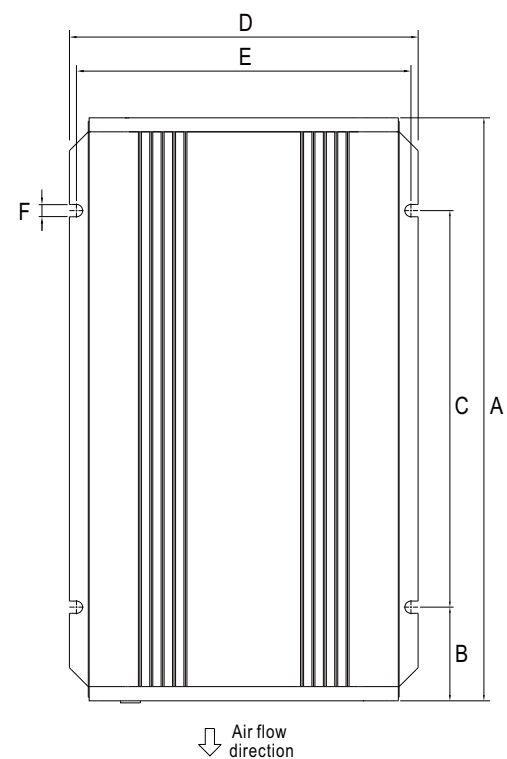

NPB/NPP-450/750/1200/1700, NPB-450NFC機構尺寸



Model	A	B	C	D	E	F	G
NPB/NPP-450 NPB-450NFC	205	39	127	135	121	5.5	55
NPB/NPP-750	230	42.5	145	158	147	7	67
NPB/NPP-1200	250	47.5	155	158	147	7	67
NPB/NPP-1700	307	76.35	155	184	173	7	70

單位:mm

選配配件(NPB/NPP-450/750/1200/1700,NPB-450NFC)

明緯訂單編號	物件		數量
CARRY HANDLE	①	提把 	1
	②	腳墊 	4
	③	螺絲 	2

① 提把

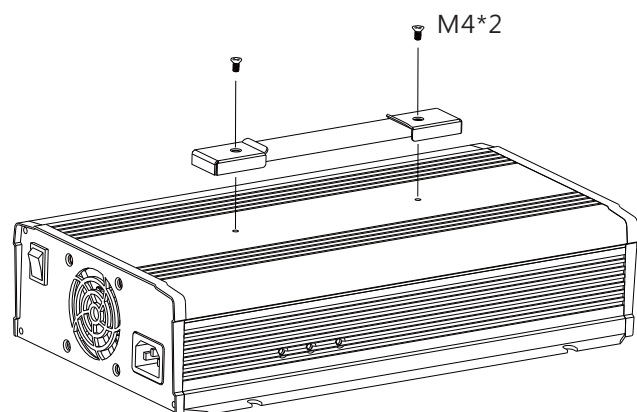

② 腳墊

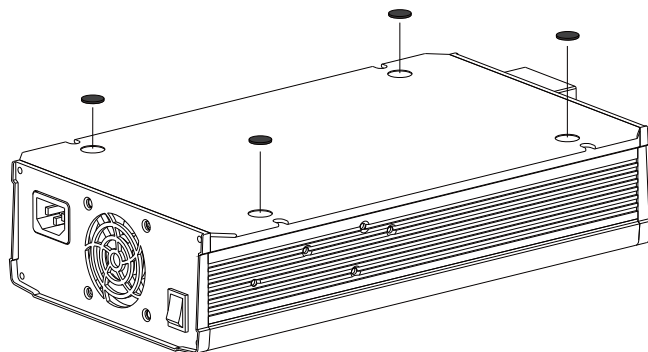

3.安裝說明

3.1 安裝注意事項

- 請勿使用於高溫、高溼的環境，避免影響充電器壽命或造成故障。
- 如為內建風扇形式，請保持前後面板通風口暢通，避免造成過熱保護而無法正常運行，建議出入風口至少須有15公分以上通風距離，如下示意圖：



圖3-1固定示意圖

3.2 安裝步驟

- ① 請先將充電器關機，將ON/OFF開關切至OFF。
- ② 挑選合適線徑之線材做為連接電池及充電器用，請參考3.3章節連接電池配線選用。
- ③ 將電池連接至充電器DC輸出端子，電池(+)端接到輸出端子(+)，電池(-)端接到輸出端子(-)，並注意正、負極勿反接或短路。

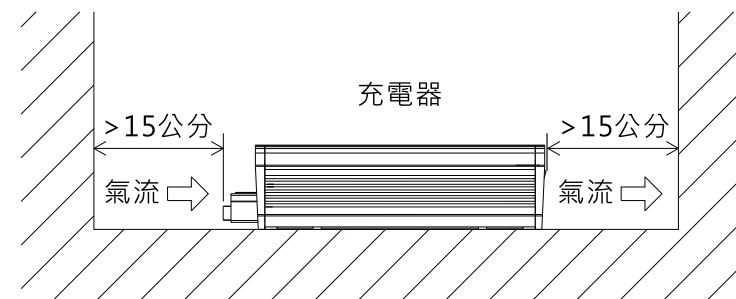

- ④ 將ON/OFF開關切至ON，LED燈號顯示為綠燈、橘燈或紅燈即為正常充電或工作。詳細LED燈號狀態，請參考4.2章節LED燈號。

3.3 電池配線選用

電池配線建議越短越好，且線徑選用需根據安規規定選取可承載電流量之導線。配線過細將會造成充電器效率偏低或無法正常滿功率輸出，並且將造成線材過熱發生著火危險。請參照下表3-1：

AWG	截面積(mm ²)	最大耐流量(A)UL1015(600V 105°C)
18	0.8	6
16	1.3	8
14	2.1	12
12	3.3	22
10	5.3	35
7	10	46
6	16	60
4	25	80
2	43	110

表3-1 線材使用建議表

3.4 電池類型與容量建議

電池種類: 鉛酸電池或鋰電池

鉛酸電池容量: 請參考下表

充電器型號	建議電池容量			
	12V model	24V model	48V model	72V model
NPB-120	20-90AH	15-50AH	7-25AH	NA
NPB-240	55-180AH	30-100AH	15-50AH	
NPB-360	65-195AH	40-125AH	20-65AH	
NPB/NPP-450 NPB-450NFC	90-300AH	45-155AH	24-80AH	19-64AH
NPB/NPP-750	150-500AH	80-260AH	40-130AH	NA
NPB/NPP-1200	240-800AH	120-420AH	60-210AH	
NPB/NPP-1700	300-1000AH	200-640AH	100-330AH	

NOTE:

- 1.電池容量大於建議值並不會損壞電池，只是電池充飽時間變長。
- 2.充電前請確認充電壓與電流是否符合電池規格。若您對電池可容許之充電電壓/電流有所疑問，請參考電池廠商所提供之技術資料或詢問電池廠商。

3.5 電池串聯與並聯

- 電池串聯：連接2顆電池串聯則電壓變為2倍，但AH容量維持不變，例如12V 100AH 串聯2顆=24V 100AH

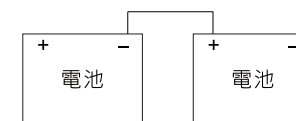

- 電池並聯：連接2顆電池並聯則電壓維持不變，但AH容量則變為2倍，例如12V 100AH 並聯2顆=12V 200AH



4. 面板與燈號顯示

4.1 面板功能說明

- Ⓐ **POWER ON/OFF開關：**
開關若切在ON的位置，則充電器開機；切在OFF則為關機。
- Ⓑ **電源輸入端**
- Ⓒ **LED指示燈：**
顯示充電器的工作狀態及充電情形。
- Ⓓ **開關或DIP開關：**
用於充電段數或曲線選取。詳細細節請參考5.2。
- Ⓔ **功能連接埠：**
用於模式控制及狀態監控等用途。詳細細節請參考4.3,4.4及4.5。
- Ⓕ **Io ADJ:**
用於輸出電流設定用。
- Ⓖ **Vo ADJ:**
用於輸出電壓設定用。
- Ⓗ **空氣進風孔：**
供充電器散熱與穩定工作，保持通風順暢，可確保產品使用壽命。
- Ⓘ **電池連接端子**
- ⓵ **NFC功能面板**

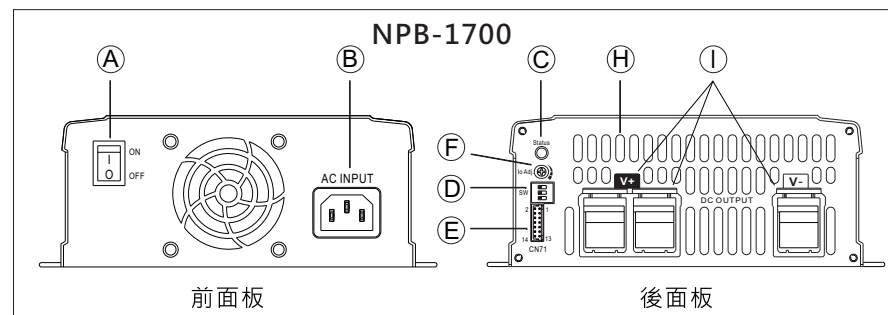
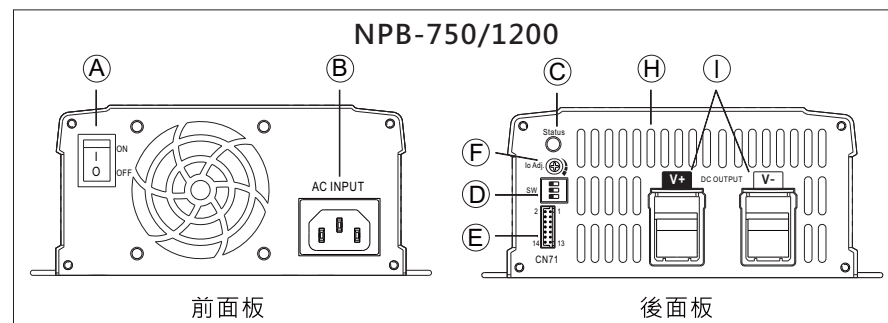
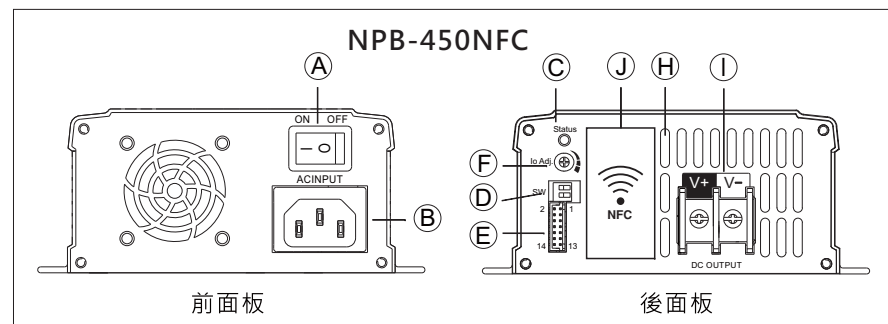
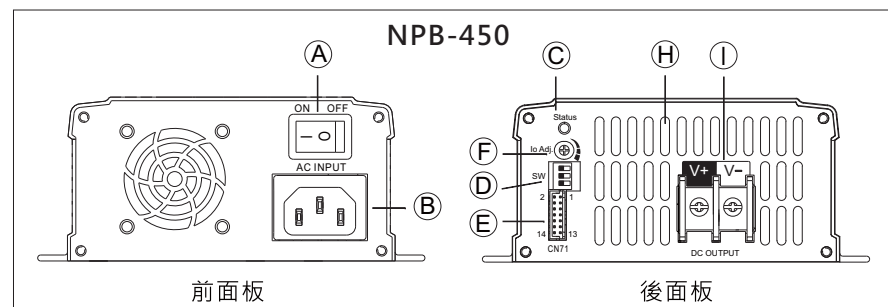
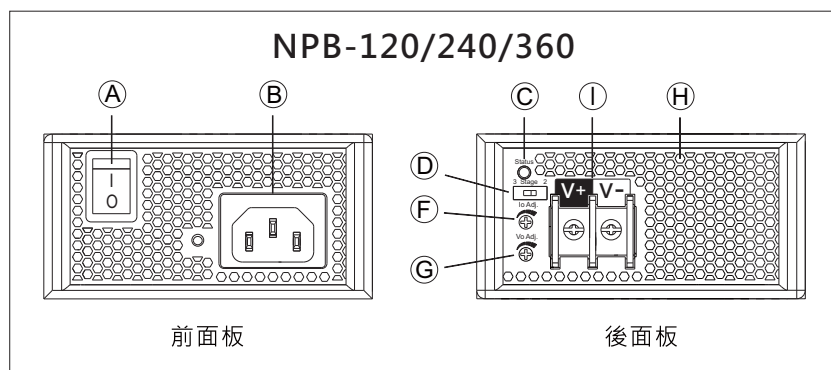

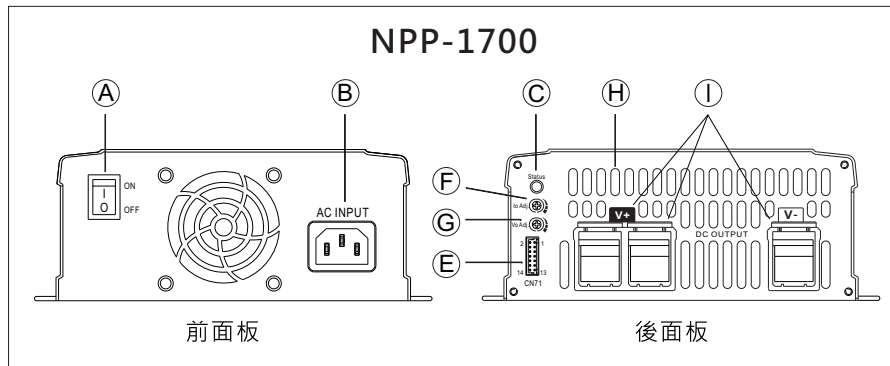
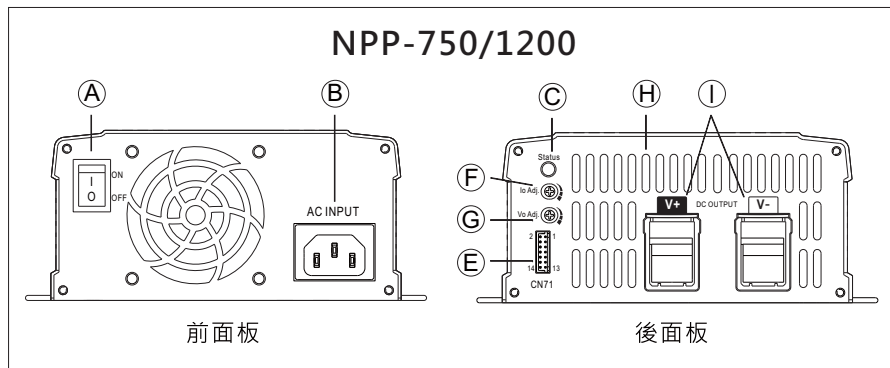
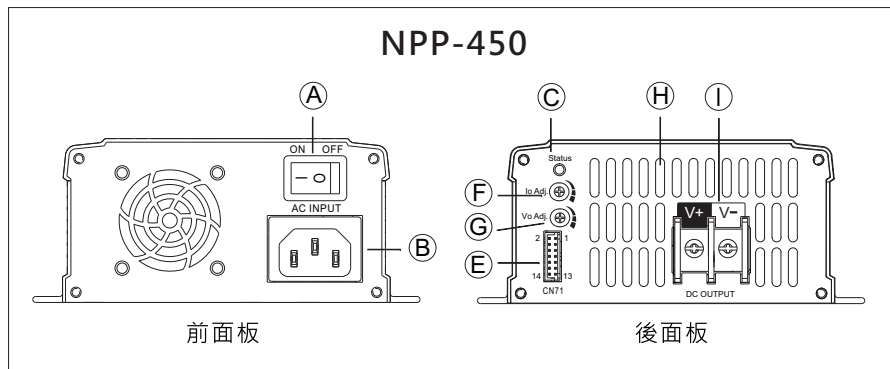

4.2 LED燈號

NPB系列型號	LED燈號	狀態說明
NPB-120 NPB-240 NPB-360	● 綠燈	浮充段(stage 3)或電池充飽
	● 紅燈	曲線充電中(stage 1或stage 2)
	○ 無燈號	異常狀態
NPB-450 NPB-450NFC NPB-750 NPB-1200 NPB-1700	● 綠燈	浮充段(stage 3)或電池充飽
	● 橘燈	曲線充電中(stage 1或stage 2)
	☀ 橘燈閃爍	自動偵壓充電模式中
	● 紅燈	異常狀態(OTP,OVP,短路,電池反接,充電超時)
	☀ 紅燈閃爍	內環溫過高

NPP系列型號	充電器模式(Default)	
	LED燈號	狀態說明
NPP-450 NPP-750 NPP-1200 NPP-1700	● 綠燈	浮充段(stage 3)或電池充飽
	● 紅燈	曲線充電中(stage 1或stage 2)
	○ 無燈號	異常狀態
	電源供應器模式	
	LED燈號	狀態說明
	● 綠燈	正常工作
	○ 無燈號	異常狀態

4.3 功能腳位說明(NPB-450/750/1200/1700)

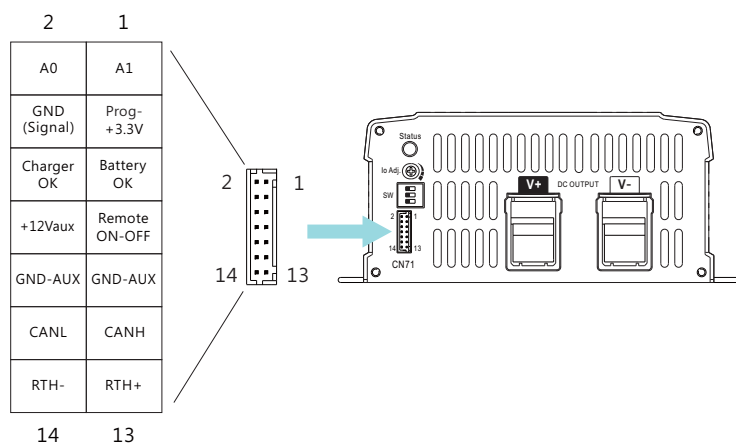

腳位	功能名稱	功能說明
1	A1	CANBus通訊介面定址用(A1)。參考地為PIN4 GND(Signal)(註1)。
2	A0	CANBus通訊介面定址用(A0)。參考地為PIN4 GND(Signal)(註1)。
3	Prog- +3.3V	+3.3V編輯器使用。
4	GND(Signal)	CANBus通訊介面定址用之參考地。
5	Battery OK	電池OK訊號，參考地為GND-AUX(pin 9&10)。此訊號為TTL訊號。最高供應電流為10mA及僅供輸出用(註2)。低電位(-0.5 ~ 0.5V): 當電池充電中。高電位(4.5 ~ 5.5V): 當電池為飽電狀態。
6	Charger OK	充電器OK訊號，參考地為GND-AUX(pin 9&10)。此訊號為TTL訊號。最高供應電流為10mA及僅供輸出用(註2)。低電位(-0.5 ~ 0.5V): 當充電器異常或保護動作時。高電位(4.5 ~ 5.5V): 當充電器正常工作時。
7	Remote ON/OFF	此腳位與+12V-AUX輔助電源之間的短路或斷開，可控制充電器啟動及關閉。短路(10.8~13.2V): 啟動; 斷開(-0.5~0.5V): 關閉; 最大輸入電壓為13.2V。
8	+12Vaux	輔助電源輸出，參考準位為GND-AUX(pin9,&10)。用於Remote ON-OFF控制用。
9,10	GND-AUX	輔助電源輸出參考地。此電源接地與主輸出(+V&-V)隔離。
11	CANH	使用於CANBus介面之數據線(註2)。
12	CANL	使用於CANBus介面之數據線(註2)。
13	RTH+	充電器隨附的溫度傳感器(NTC 5K Ohm)可連接至設備，作為鉛酸電池的充電電壓進行溫度補償。
14	RTH-	

註1：非隔離信號，參考到輸出端[GND(signal)]。
 註2：隔離信號，參考到GND-AUX。

4.4 功能腳位說明(NPB-450NFC)

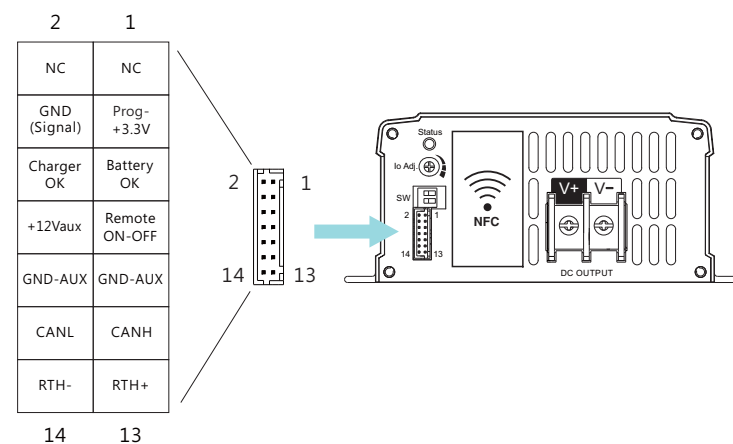

腳位	功能名稱	功能說明
1	NC	未使用
2	NC	未使用
3	Prog- +3.3V	+3.3V 電壓輸出, 參考地為Pin 4 GND(信號) (註1)。
4	GND(Signal)	CANBus通訊介面定址用之參考地。
5	Battery OK	電池OK訊號，參考地為GND-AUX(pin 9&10)。此訊號為TTL訊號。最高供應電流為10mA及僅供輸出用(註2)。低電位(-0.5 ~ 0.5V): 當電池充電中。高電位(4.5 ~ 5.5V): 當電池為飽電狀態。
6	Charger OK	充電器OK訊號，參考地為GND-AUX(pin 9&10)。此訊號為TTL訊號。最高供應電流為10mA及僅供輸出用(註2)。低電位(-0.5 ~ 0.5V): 當充電器異常或保護動作時。高電位(4.5 ~ 5.5V): 當充電器正常工作時。
7	Remote ON/OFF	此腳位與+12V-AUX輔助電源之間的短路或斷開，可控制充電器啟動及關閉。短路(10.8~13.2V): 啟動; 斷開(-0.5~0.5V): 關閉; 最大輸入電壓為13.2V。
8	+12Vaux	輔助電源輸出，參考準位為GND-AUX(pin9,&10)。用於Remote ON-OFF控制用。
9,10	GND-AUX	輔助電源輸出參考地。此電源接地與主輸出(+V&-V)隔離。
11	CANH	使用於CANBus介面之數據線(註2)。
12	CANL	使用於CANBus介面之數據線(註2)。
13	RTH+	充電器隨附的溫度傳感器(NTC 5K Ohm)可連接至設備，作為鉛酸電池的充電電壓進行溫度補償。
14	RTH-	

註1：非隔離信號，參考到輸出端[GND(signal)]。
 註2：隔離信號，參考到GND-AUX。
 註3：NFC機型Pin1,Pin2未使用，CANBus通訊位址請參考APP實際讀值。

4.5 功能腳位說明(NPP-450/750/1200/1700)

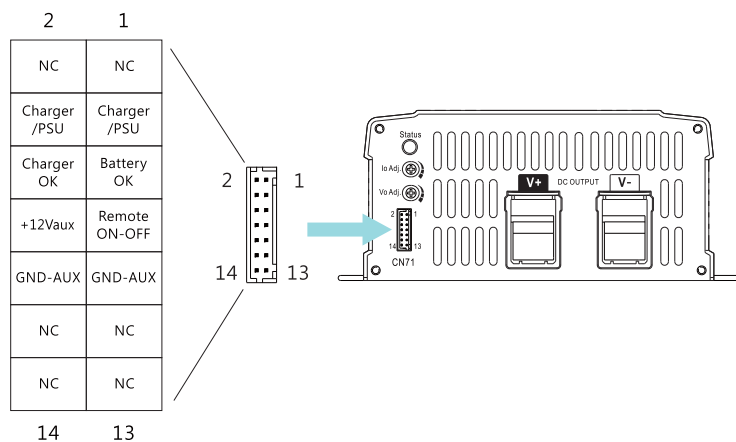

腳位	功能名稱	功能說明
1,2, 11~14	NC	未使用。
3,4	Charger/ PSU	開路: 充電器模式。LED指示燈之燈色請參考4.2節。 短路: 電源供應器模式。LED指示燈之燈色為常亮綠色。
5	Battery OK	電池OK訊號，參考地為GND-AUX(pin 9&10)。此訊號為TTL訊號。最高供應電流為10mA及僅供輸出用(註)。低電位(-0.5 ~ 0.5V): 當電池充電中。高電位(4.5 ~ 5.5V): 當電池為飽電狀態。
6	Charger OK	充電器正常信號，參考GND-AUX(Pin9 & 10)。該信號是TTL信號。最大源電流為10mA，僅用於輸出。(註) 低電位(-0.5 ~ 0.5V): 當充電器發生故障或保護功能啟動時。高電位(4.5 ~ 5.5V): 充電器正常工作時。
7	Remote ON/OFF	此腳位與+12V-AUX輔助電源之間的短路或斷開，可控制充電器啟動及關閉。短路(10.8~13.2V): 啟動; 斷開(-0.5~0.5V): 關閉; 最大輸入電壓為13.2V。
8	+12Vaux	輔助電源輸出，參考準位為GND-AUX(pin9,&10)。用於Remote ON-OFF控制用。
9,10	GND-AUX	輔助電源輸出參考地。此電源接地與主輸出(+V&-V)隔離。

註：隔離信號，參考到GND-AUX。

5.功能與操作

5.1 功能差異表

	NPB-120/240/360	NPB-450/750/1200/1700	NPB-450NFC	NPP series
LED燈號顯示	紅/綠/無	紅/橘/綠	紅/橘/綠	紅/綠/無
2/3段充電切換(DIP S.W.)	2/3	2/3	X	3
預設充電曲線設定(DIP S.W.)	X	●	●	X
智能充電曲線編程(SBP-001)	X	●	●	X
ADJ充電電壓/電流調整	●	X	X	●
CANBus通訊	X	●	●	X
電源供應器/充電器模式切換	X	●	●	●
智能偵壓充電模式	X	●	●	X
遙控開關	X	●	●	●
反極性保護	●	●	●	X
充電器OK訊號	X	●	●	●
電池充飽OK訊號	X	●	●	●
溫度補償	X	●(3 stage only)	●(3 stage only)	X
NFC功能支援	X	X	●	X

5.2 功能說明

5.2.1 DIP開關說明(NPB only)

- NPB系列搭配DIP開關，可以使用來切換2段或是3段式充電。
- NPB-450/450NFC/750/1200/1700除了可以使用DIP開關切換充電段數外，更可使用DIP開關切換4種預設的充電曲線。詳細內容請參考5.3操作模式(2/3段式充電)及5.4充電曲線設定。

NPB-120/240/360(Default設定為3 stage)

※ 開關

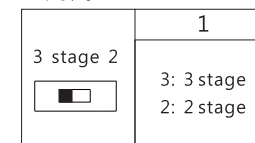

NPB-450/750/1200/1700 (Default設定為3 stage, 預設設定為可程式設計曲線)

※ DIP開關

	1	2	3	Description
	OFF: 3 stage ON: 2 stage	OFF	OFF	Default, programmable
		ON	OFF	Pre-defined, Gel battery
	ON: 2 stage	OFF	ON	Pre-defined, flooded battery
ON		ON	Pre-defined, AGM battery, LiFe04	

NPB-450NFC(Default設定為3stage,2/3stage充電設定需通過APP完成)

※ DIP開關

	1	2	Description
	OFF	OFF	Default, programmable
	ON	OFF	Pre-defined, Gel battery
	OFF	ON	Pre-defined, flooded battery
ON	ON	Pre-defined, AGM battery, LiFe04	

5.2.2 充電器/電源供應器模式切換(NPP only)

藉由此功能來設定NPP系列的工作模式。

- 充電器模式：可使用來對電池充電使用
- 電源供應器模式：可直接搭配一般負載使用

PIN3與PIN4之間	模式
開路	充電器
短路	電源供應器

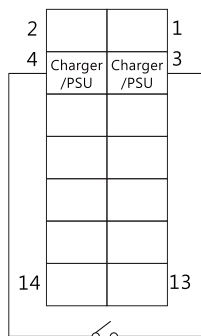

5.2.3 遙控開關(NPB/NPP-450/750/1200/1700,NPB-450NFC)

藉由使用「遙控開關」功能來改變充電器的ON/OFF狀態。

遙控開關和+12Vaux之間	充電器
短路	Remote ON
開路	Remote OFF

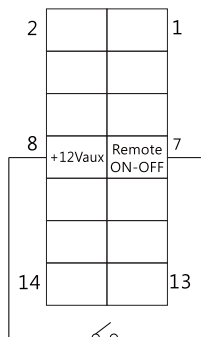

5.2.4 充電器OK訊號(NPB/NPP-450/750/1200/1700,NPB-450NFC)

充電器 OK訊號為TTL訊號。最高供應電流為10mA及僅供輸出用。

充電器OK訊號	充電器狀態
"High": 4.5 ~ 5.5V	正常工作
"Low": -0.5 ~ 0.5V	異常或進入保護狀態

NOTE: GND-AUX可為PIN9或PIN10

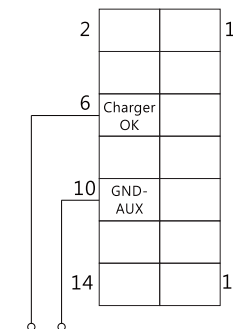

5.2.5 電池OK訊號(NPB/NPP-450/750/1200/1700,NPB-450NFC)

電池 OK訊號為TTL訊號。最高供應電流為10mA及僅供輸出用。

電池OK訊號	充電器狀態
"High": 4.5 ~ 5.5V	充電完成
"Low": -0.5 ~ 0.5V	電池充電中

NOTE: GND-AUX可為PIN9或PIN10

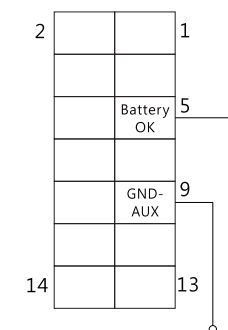

5.2.6 溫度補償(NPB-450/450NFC/750/1200/1700)

- 隨充電器附上溫度感應器，可以連接到充電器來感應電池溫度做充電電壓的溫度補償。在感應器沒有使用下，充電器仍然可正常地工作。
- 預設為-3mV/°C/Cell，使用隨機附贈的NTC NSG05C250J5-500V連接至後面板通訊端子Rth+與Rth-。NTC感測線的線長可自行調整，藉由連接需要的線長至NTC感測器部分與連結器部分。補償電壓如下表：

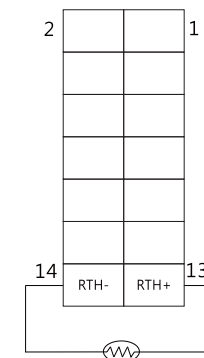

機型	補償輸出電壓上限	補償輸出電壓下限	電池溫度補償範圍
12V	15.3V	13.2V	0 ~ 40°C
24V	30.6V	26.4V	
48V	61.2V	52.8V	
72V (NPB-450/450NFC only)	76.5V	66V	

NOTE:

- 1.如需設定為不同補償範圍，需搭配SBP-001或CANBus重新設定。
- 2.溫度補償功能僅會於3 stage動作補償。

5.2.7 智能偵壓充電模式(NPB-450/450NFC/750/1200/1700)

智能偵壓充電模式係透過產品內建MCU對電池於充電過程中進行智能充電演算，依據演算結果得到電池特性及其電池芯單元配置並直接完成充電程序，透過智能充電演算法，使用者無需額外設定充電曲線。

警告：

NPB-450/450NFC/750/1200/1700設計涵蓋三種不同之電壓充電範圍：10.5V~21V(12V Model); 21V~42V(24V Model); 42V~80V(48V Model)。54~100V(72V Model)。NPB-450/450NFC only)因鋰電池屬高危險物質，充電電壓過高或錯誤可能會產生危害或燃燒。例：鋰鐵電池最高充電電壓為14.6V，只能使用NPB-1700-12充電。只適用單體電池，請確認您的鋰電池有BMS(電池管理系統)方能使用此充電功能。

智能偵壓充電模式設定

NPB-450/450NFC/750/1200/1700預設為曲線充電控制模式，若要進行智能偵壓模式設定，須在Remote off狀態下進行曲線選擇DIP關關的切換，程序如下：

- ① 在未送電狀態下，將充電曲線選擇DIP開關都切至全"OFF"
- ② Remote off狀態下AC送電
- ③ AC送電15秒內，將DIP開關都切至全"ON"，再切回全"OFF"
- ④ 綠色LED閃爍3次表示設定成功
- ⑤ Remote on後將會切換成智能偵壓充電模式

NOTE:

- 1.智能偵壓模式充電僅適用於搭載BMS(電池管理系統)功能之鋰電池。
- 2.鋰電池電壓特性受溫度影響較小，故智能偵壓模式不支援溫度補償功能。
- 3.智能偵壓模式下使用者無法自行設定充電電壓或段數(2段或3段)。但可依據不同電池容量大小調降Io ADJ 50~100%，以限制電流輸出 (default: 100%)。
- 4.如使用上有任何問題，請洽明緯或當地經銷商協助。

5.2.8 風扇轉速控制

NPB-360及NPP-450/750/1200/1700為內建風扇開/關電路，風扇會依溫度高低打開/關閉風扇。

NPB-450/450NFC/750/1200/1700為內建風扇轉速控制電路，風扇轉速會依溫度高低而調整。

5.3 操作模式(2/3段式充電)

NPB共有2段式、3段式二種充電操作模式可供選擇，NPP則有3段式充電模式可供選擇。2段式充電可說是簡易快速充電，3段式充電相同於2段式而電池充飽後不關機，使用者可依實際需求來選擇2段式、3段式充電。

5.3.1 2段式充電(DIP開關切至"2"stage)

於充電初期，充電器以最大電流對電池充電，風扇轉動(內建風扇機型)，經過一段時間後(視電池容量而定)，充電電流逐漸下降，當充電電流下降至最大電流之10%左右時，LED指示燈亮綠燈，表示充電完成，NPB-450/450NFC/750/1200/1700於2段充電結束後會關閉輸出；NPB-120/240/360則會持續輸出。

NPB-120/240/360 2段式充電曲線

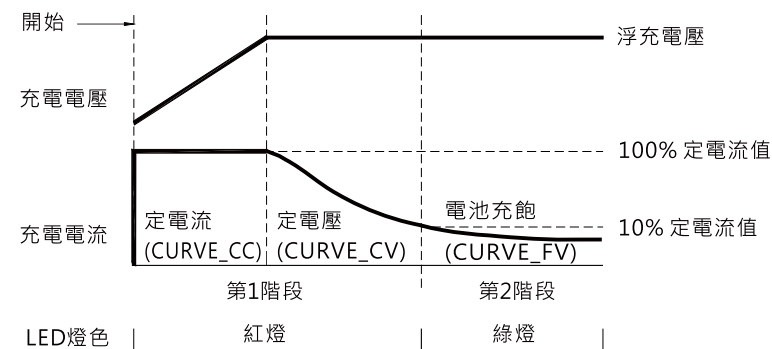

NPB-450/450NFC/750/1200/1700 2段式充電曲線

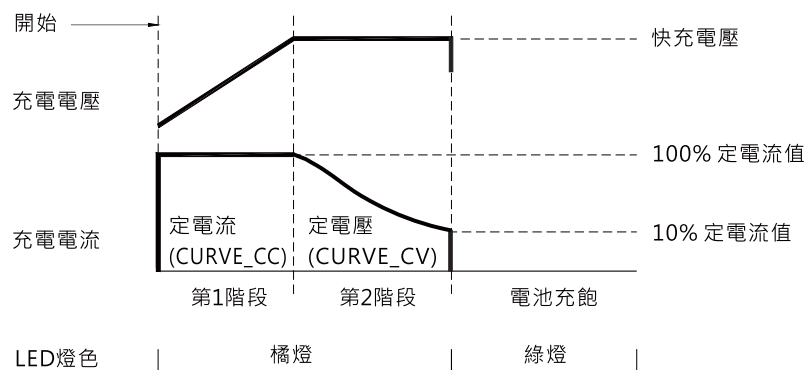

狀態	12V model	24V model	48V model	72V model
NPB-120定電流	6.8A	4A	2A	NA
NPB-240定電流	13.5A	8A	4A	
NPB-360定電流	20A	12A	6A	
NPB-450/450NFC定電流	25A	13.5A	6.8A	5.5A
NPB-750定電流	43A	22.5A	11.3A	NA
NPB-1200定電流	70A	36A	18A	
NPB-1700定電流	85A	50A	25A	
快充電壓	14.4V	28.8V	57.6V	72V

圖5.1 2段式充電曲線(Default設定)

2段充電曲線說明

- 開始階段(電瓶分析)：
 - 透過對電池電壓之偵測，判斷是否未接電池/電池逆接/電池電壓是否正確，或電池是否已充滿無需再充電。
 - * NPB-450/450NFC/750/1200/1700才有此功能。
- 第1階段(定電流)：
 - 此階段以高恆定電流快速充電，直到電池電壓達到快充電壓。
- 第2階段(定電壓)：
 - 此階段提供一恆定電壓(快充電壓)對電池進行充電，使充電電流慢慢下降至快充電流的10%電流量即結束充電。
 - * 適用於鉛酸電池(加水式、膠體式、吸附玻璃纖維式等)或鋰電池(鋰鐵、鋰錳、鋰三元等)。
 - * NPB-120/240/360於2階段充電結束後會持續浮充電壓。

5.3.2 3段式充電(DIP開關切至"3"stage)

於充電初期，充電器以最大電流對電池充電，風扇轉動(內建風扇機型)，經過一段時間後(視電池容量而定)，充電電流逐漸下降，當充電電流下降至最大電流之10%左右時，LED指示燈亮綠燈，表示充電完成，此時充電器輸出會維持浮充狀態。

NPB,NPP-450/750/1200/1700,NPB-450NFC 3段式充電曲線

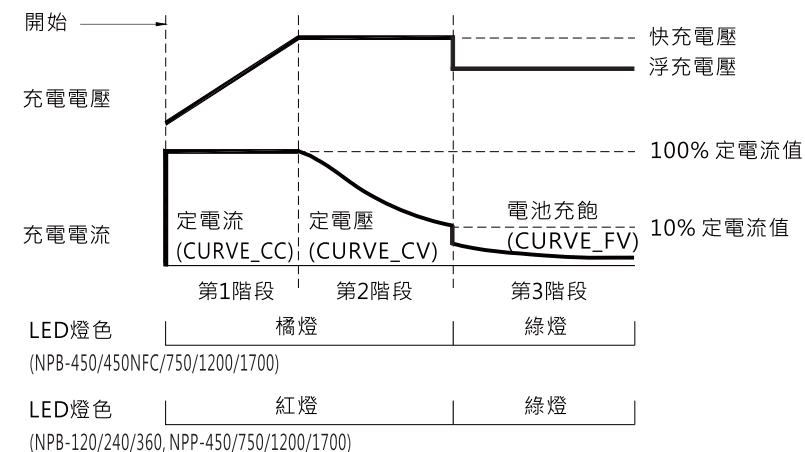

狀態	12V model	24V model	48V model	72V model
NPB-120定電流	6.8A	4A	2A	NA
NPB-240定電流	13.5A	8A	4A	
NPB-360定電流	20A	12A	6A	
NPB/NPP-450, NPB-450NFC定電流	25A	13.5A	6.8A	5.5A
NPB/NPP-750定電流	43A	22.5A	11.3A	NA
NPB/NPP-1200定電流	70A	36A	18A	
NPB/NPP-1700定電流	85A	50A	25A	
快充電壓	14.4V	28.8V	57.6V	72V
浮充電壓	13.8V	27.6V	55.2V	69V

圖5.2 3段式充電曲線(Default設定)

3段充電曲線說明

- 開始階段(電瓶分析)：
 - 透過對電池電壓之偵測，判斷是否未接電池/電池逆接/電池電壓是否正確。
 - * NPB-450/450NFC/750/1200/1700才有此功能。

② 第1階段(定電流)：

此階段以高恆定電流快速充電，直到電池電壓達到快充電壓。

③ 第2階段(定電壓)：

此階段提供一恆定電壓(快充電壓)對電池進行充電，使充電電流慢慢下降至快充電流的10%電流量即結束充電。

④ 第3階段(浮充)：

提供浮充電壓維持在浮充電壓，使電池能夠保持充飽能量。

* 適用於鉛酸電池(加水式、膠體式、吸附玻璃纖維式等)。

5.4 充電曲線設定(NPB-450/450NFC/750/1200/1700)

5.4.1 DIP開關曲線設定

出廠設定為default曲線，若須變更充電參數，後面板上提供一DIP開關(如右)，可透過DIP開關切換位置並改變曲線，NFC机型默认处于3 stage充电曲线，需通过app方可设置2 stage充电曲线。其對應曲線及電壓範圍如下。

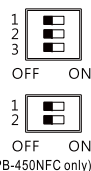

內建的2段式充電曲線規格

DIP S.W position			12V model				Vboost	
1	2	3	Description	CC (default)				
ON	OFF	OFF	Default, programmable	25A NPB-450/ 450NFC	43A NPB-750	70A NPB-1200	85A NPB-1700	14.4
ON	ON	OFF	Pre-defined, gel battery					14.0
ON	OFF	ON	Pre-defined, flooded battery					14.2
ON	ON	ON	Pre-defined, AGM battery, LiFe04					14.6
DIP S.W position			24V model				Vboost	
1	2	3	Description	CC (default)				
ON	OFF	OFF	Default, programmable	13.5A NPB-450/ 450NFC	22.5A NPB-750	36A NPB-1200	50A NPB-1700	28.8
ON	ON	OFF	Pre-defined, gel battery					28.0
ON	OFF	ON	Pre-defined, flooded battery					28.4
ON	ON	ON	Pre-defined, AGM battery, LiFe04					29.2
DIP S.W position			48V model				Vboost	
1	2	3	Description	CC (default)				
ON	OFF	OFF	Default, programmable	6.8A NPB-450/ 450NFC	11.3A NPB-750	18A NPB-1200	25A NPB-1700	57.6
ON	ON	OFF	Pre-defined, gel battery					56.0
ON	OFF	ON	Pre-defined, flooded battery					56.8
ON	ON	ON	Pre-defined, AGM battery, LiFe04					58.4
DIP S.W position			72V model				Vboost	
1	2	3	Description	CC (default)				
ON	OFF	OFF	Default, programmable	5.5A NPB-450/ 450NFC	NA			72
ON	ON	OFF	Pre-defined, gel battery					70
ON	OFF	ON	Pre-defined, flooded battery					71
ON	ON	ON	Pre-defined, AGM battery, LiFe04					73

NOTE：電壓誤差 ±2%

內建的3段式充電曲線規格

DIP S.W position			12V model				Vboost	Vfloat	
1	2	3	Description	CC (default)					
OFF	OFF	OFF	Default, programmable	25A NPB-450/ 450NFC	43A NPB-750	70A NPB-1200	85A NPB-1700	14.4	13.8
OFF	ON	OFF	Pre-defined, gel battery					14.0	13.6
OFF	OFF	ON	Pre-defined, flooded battery					14.2	13.4
OFF	ON	ON	Pre-defined, AGM battery, LiFe04					14.6	14.0
DIP S.W position			24V model				Vboost	Vfloat	
1	2	3	Description	CC (default)					
OFF	OFF	OFF	Default, programmable	13.5A NPB-450/ 450NFC	22.5A NPB-750	36A NPB-1200	50A NPB-1700	28.8	27.6
OFF	ON	OFF	Pre-defined, gel battery					28.0	27.2
OFF	OFF	ON	Pre-defined, flooded battery					28.4	26.8
OFF	ON	ON	Pre-defined, AGM battery, LiFe04					29.2	28.0
DIP S.W position			48V model				Vboost	Vfloat	
1	2	3	Description	CC (default)					
OFF	OFF	OFF	Default, programmable	6.8A NPB-450/ 450NFC	11.3A NPB-750	18A NPB-1200	25A NPB-1700	57.6	55.2
OFF	ON	OFF	Pre-defined, gel battery					56.0	54.4
OFF	OFF	ON	Pre-defined, flooded battery					56.8	53.6
OFF	ON	ON	Pre-defined, AGM battery, LiFe04					58.4	56.0
DIP S.W position			72V model				Vboost	Vfloat	
1	2	3	Description	CC (default)					
OFF	OFF	OFF	Default, programmable	5.5A NPB-450/ 450NFC	NA			72	69
OFF	ON	OFF	Pre-defined, gel battery					70	68
OFF	OFF	ON	Pre-defined, flooded battery					71	67
OFF	ON	ON	Pre-defined, AGM battery, LiFe04					73	70

NOTE：電壓誤差 ±2%

5.4.2 智能充電曲線編程

SBP-001為明緯自行開發之智能電池充電編程器，可透過曲線編輯軟體設定NPB系列之充電曲線。SBP-001提供的功能有充電曲線調整、電池溫度補償等。使用時請先將DIP開關腳位設定為Default, programmable (PIN2: OFF; PIN3: OFF)。安裝配置及軟體介面，以NPB-1200為例，示意如下。各機型之詳細使用內容請參考「SBP-001智能化可編程電池充電器編輯軟體使用手冊」。

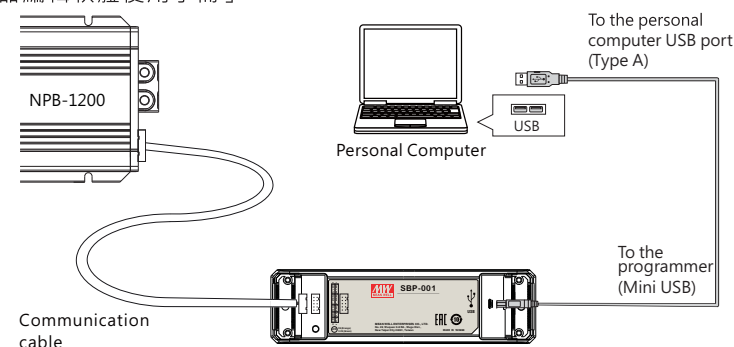

軟體使用者介面示意圖：

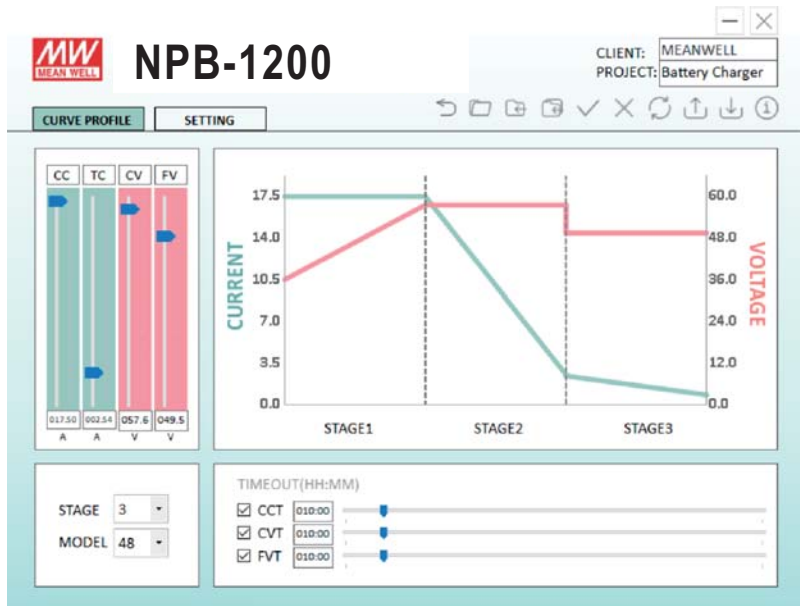

5.5 回復原廠設定

若要進行回復原廠設定，則須在Remote off狀態下進行曲線選擇DIP開關的切換，程序如下：

- ① 在未送電狀態下，將充電曲線選擇DIP開關都切至全"ON"
- ② Remote off狀態下AC送電
- ③ AC送電15秒內，將DIP開關都切至全"OFF"，再切回全"ON"
- ④ 綠色LED閃爍3次表示設定成功
- ⑤ 重新開機並Remote on後將會回復原廠設定

NOTE: NPB-450NFC回復出廠設定後，會清除密碼設定

6. CANBus通訊(NPB-450~1700)

CANBus提供控制及監視功能，對於有即時監控或是線上修改設定需求的客戶提供絕佳的使用體驗。使用者可以透過CANBus並利用控制器(Master)讀取或寫入設定參數，參數包含：ON/OFF、輸出電壓/電流、溫度等。更可以用來設定充電曲線及其參數，例如：定電流、定電壓、浮充電壓及超時功能等。詳細的資訊，請參考以下章節。

6.1 CANBus相關規格

- 實體層傳輸
本協定採用CAN ISO-11898，Baud rate為250Kbps。
- 協定框架格式
本協定採用CAN 2.0B，使用擴充型資料框的傳輸格式。

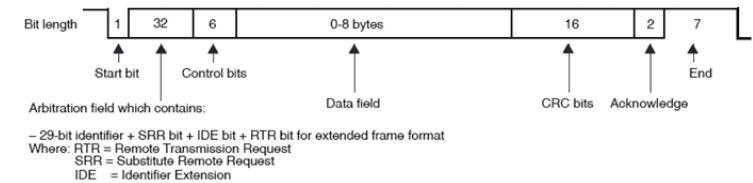

- 通訊時序
Min. request period (Controller to PSU/CHG): 20mSec。
Max. response time (PSU/CHG to Controller): 5mSec。
Min. packet margin time (Controller to PSU/CHG): 5mSec。

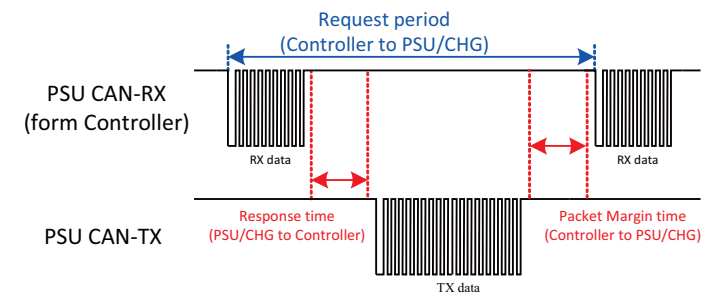

- 數據格式
① 控制器到NPB series (≥450W)

◎ 寫入: 範例請參考6.4.1小節

Data Field Bytes

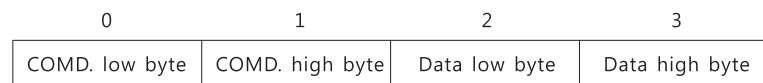

◎ 讀取: 範例請參考6.4.2小節

Data Field Bytes

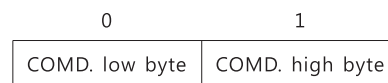

② NPB series到控制器 (≥450W)

◎ 回復: 範例請參考6.4.2小節

Data Field Bytes

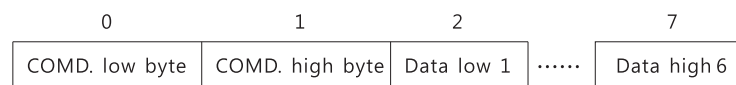

注: NPB系列(≥450W)在寫參數時不會回傳訊息, 例如 VOUT_SET

6.2 CANBus匯流排位址設定

使用CANBus通訊時, 每台充電器需設定唯一且不重複之設備位址, 其中CN71之A0-A1(PIN0PIN1)可用來選擇位址(最大可指定之位址: 4個), 參考準位為GND(Signal)(PIN4)。設備位址設定如下所示:

A0/A1與GND(Signal)之間	logic
開路	1
短路	0

Device No.	Device address	
	A1	A0
0	0	0
1	0	1
2	1	0
3	1	1

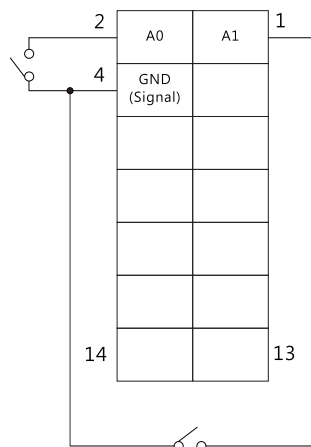

Message ID定義說明:

敘述	Message ID
充電器對控制器 Message ID	0x000C00XX
控制器對充電器 Message ID	0x000C01XX
控制器對充電器廣播 Message ID	0x000C01FF

NOTE:

1. XX代表該NPB-450/750/1200/1700之位址(由定址訊號A0~A1:決定, 範圍為0x00~0x03)
2. NPB-450-xxNFC系列定址由NFC介面設定, 範圍為0x00~0x0F。

6.3 CANBus命令支援表

Command Code	Command Name	Transaction Type	# of data Bytes	Description
0x0000	OPERATION	R/W	1	開啟/關閉控制
0x0020	VOUT_SET	R/W	2	輸出電壓設定 (format: value, F=0.01)
0x0030	IOUT_SET	R/W	2	輸出電流設定 (format: value, F=0.01)
0x0040	FAULT_STATUS	R	2	異常狀態
0x0050	READ_VIN (NPB-450/450NFC/750不支援)	R	2	輸入電壓讀值 (format: value, F=0.1)
0x0060	READ_VOUT	R	2	輸出電壓讀值 (format: value, F=0.01)
0x0061	READ_IOUT	R	2	輸出電流讀值 (format: value, F=0.01)
0x0062	READ_TEMPERATURE_1	R	2	內環境溫度讀值 (format: value, F=0.1)
0x0080	MFR_ID_B0B5	R	6	製造商名稱
0x0081	MFR_ID_B6B11	R	6	製造商名稱

Valid when CURVE_CONFIG: CURVE = 1

Command Code	Command Name	Transaction Type	# of data Bytes	Description
0x0082	MFR_MODEL_B0B5	R	6	製造商機型名稱
0x0083	MFR_MODEL_B6B11	R	6	製造商機型名稱
0x0084	MFR_REVISION_B0B5	R	6	韌體版本
0x0085	MFR_LOCATION_B0B2	R/W	3	製造產地
0x0086	MFR_DATE_B0B5	R/W	6	製造日期
0x0087	MFR_SERIAL_B0B5	R/W	6	製造序號
0x0088	MFR_SERIAL_B6B11	R/W	6	製造序號
0x00B0	CURVE_CC	R/W	2	充電曲線定電流 (format: value, F=0.01)
0x00B1	CURVE_CV	R/W	2	充電曲線定電壓 (format: value, F=0.01)
0x00B2	CURVE_FV	R/W	2	充電曲線浮充電壓 (format: value, F=0.01)
0x00B3	CURVE_TC	R/W	2	充電曲線轉態電流 (format: value, F=0.01)
0x00B4	CURVE_CONFIG	R/W	2	充電器功能
0x00B5	CURVE_CC_TIMEOUT	R/W	2	充電曲線定電流充電計時
0x00B6	CURVE_CV_TIMEOUT	R/W	2	充電曲線定電壓充電計時
0x00B7	CURVE_FV_TIMEOUT	R/W	2	充電曲線浮充電計時
0x00B8	CHG_STATUS	R	2	充電器狀態
0x00B9	CHG_RST_VBAT	R/W	2	充飽後重啟充電的 電壓點設定
0x00C0	SCALING_FACTOR	R	2	比例因子
0x00C1	SYSTEM_STATUS	R	2	系統狀態
0x00C2	SYSTEM_CONFIG	R/W	2	系統設定

NOTE: 設定、讀取數值換算定義如下：

實際值 = 通訊讀值 × Factor(F值)。其中Factor需參照各機型清單的SCALING_FACTOR定義。

EX: $Vo_real(\text{輸出電壓實際值}) = \text{READ_VOUT} \times \text{Factor}$ 。

若某機型READ_VOUT的Factor為0.01、通訊讀值為0x0960(16進制)
=>2400(10進制)，則 $Vo_real = 2400 \times 0.01 = 24.00V$ 。

FAULT_STATUS(0x00 40):

Low byte	Bit7	Bit6	Bit5	Bit4	Bit3	Bit2	Bit1	Bit0
Definition	HI_TEMP	OP_OFF	AC_FAIL	SHORT	OLP	OVP	OTP	---

Bit 1 OTP: 輸出過溫保護旗標

0 = 內部溫度正常
1 = 溫度過高保護

Bit 2 OVP: 輸出過壓保護旗標

0 = 輸出電壓正常
1 = 輸出過壓保護

Bit 3 OLP: 輸出過流保護旗標

0 = 輸出電流正常
1 = 輸出過流保護

Bit 4 SHORT: 輸出短路保護旗標

0 = 無輸出短路
1 = 輸出短路保護

Bit 5 AC_FAIL: 輸入電壓異常旗標

0 = AC電壓正常
1 = AC電壓異常保護

Bit6 OP_OFF: 輸出關閉指示

0 = 輸出開啟
1 = 輸出關閉

Bit7 HI_TEMP: 內部高溫警告旗標

0 = 內部溫度正常

1 = 內部溫度過高

CHG_STATUS(0x00 B8) :

High byte	Bit7	Bit6	Bit5	Bit4	Bit3	Bit2	Bit1	Bit0
High byte	FVTOF	CVTOF	CCTOF	---	BTNC	NTCER	---	---
Low byte	Bit7	Bit6	Bit5	Bit4	Bit3	Bit2	Bit1	Bit0
Low byte	---	WAKEUP_STOP	---	---	FVM	CVM	CCM	FULLM

High byte

Bit 2 NTCER: 溫度補償短路

0 = 溫度補償線路無發生短路

1 = 溫度補償線路發生短路

Bit 3 BTNC: 電池未接

0 = 偵測到電池

1 = 未偵測到電池

Bit 5 CCTOF: 定電流階段充電超時旗標

0 = 定電流階段充電未超時

1 = 定電流階段充電超時

Bit 6 CVTOF: 定電壓階段充電超時旗標

0 = 定電壓階段充電未超時

1 = 定電壓階段充電超時

Bit 7 FVTOF: 浮充階段充電超時旗標

0 = 浮充階段充電未超時

1 = 浮充階段充電超時

Low byte

Bit 0 FULLM: 充飽電模式狀態

0 = 未充飽電

1 = 充飽電

Bit 1 CCM: 定電流充電模式狀態

0 = 充電器非處於定電流模式

1 = 機器處於初始化狀態

Bit 2 CVM: 定電壓充電模式狀態

0 = 充電器非處於定電壓模式

1 = 充電器處於定電壓模式

Bit 3 FVM: 浮充模式狀態

0 = 充電器非處於浮充模式

1 = 充電器處於浮充模式

Bit 6 WAKEUP_STOP: 喚醒結束

0 = 喚醒結束

1 = 喚醒未結束

SYSTEM_STATUS(0x00 C1):

Low byte	Bit7	Bit6	Bit5	Bit4	Bit3	Bit2	Bit1	Bit0
Definition	---	EEPER	INITIAL_STATE	---	---	---	DC_OK	---

Low byte

Bit 1 DC_OK: DC_OK旗標

0 = 輸出電壓正常

1 = 輸出電壓異常

Bit 5 INITIAL_STATE: 機器初始化狀態

0 = 機器未處於初始化狀態

1 = 機器處於初始化狀態

Bit 6 EEPER: EEPROM資訊存取錯誤

0 = EEPROM資料存取正常

1 = EEPROM資料存取錯誤

NOTE: EEPER: 發生EEPROM資料錯誤時，機器關機進入保護，LED不亮燈。待狀況解除後重新開機才能啟動。

CURVE_CONFIG(僅於充電模式有效)(0x00 B4):

High byte	Bit7	Bit6	Bit5	Bit4	Bit3	Bit2	Bit1	Bit0
Definition	---	---	---	---	RSTE	FVTOE	CVTOE	CCTOE
Low byte	Bit7	Bit6	Bit5	Bit4	Bit3	Bit2	Bit1	Bit0
Definition	CUVE	---	---	---	TCS		CUVS	

Low byte

Bit 0-1 CUVS: 充電曲線選擇

00 = 載入客戶燒錄充電曲線(default)

01 = 載入預設充電曲線#1

10 = 載入預設充電曲線#2

11 = 載入預設充電曲線#3

Bit 2-3 TCS: 溫度補償設定

00 = disable

01 = -3mV/°C/cell(default)

01 = -4mV/°C/cell

01 = -5mV/°C/cell

Bit 7 CUVE: 充電曲線致能

0 = 關閉 · 電源模式

1 = 開啟 · 充電模式(default)

High byte

Bit 0 CCTOE: 定電流階段充電超時致能

0 = 關閉(default)

1 = 開啟

Bit 1 CVTOE: 定電壓階段充電超時致能

0 = 關閉(default)

1 = 開啟

Bit 2 FVTOE: 浮充階段充電超時致能

0 = 關閉(default)

1 = 開啟

Bit 3 RSTE : 充飽後重啟充電功能使能

0 = 關閉(default)

1 = 開啟 · 當電池電壓低於設定值 · 重啟充電程式 · 詳情請參考56頁關於0x00B9(CHG_RST_BAT)相關之說明

SYSTEM_CONFIG(0x00 C2):

High byte	Bit15	Bit14	Bit13	Bit12	Bit11	Bit10	Bit9	Bit8
Definition	Reserved	Reserved	Reserved	Reserved	Reserved	EEP_OFF	EEP_CONFIG	
Supported	NO	NO	NO	NO	NO	YES	NO	
Low byte	Bit7	Bit6	Bit5	Bit4	Bit3	Bit2	Bit1	Bit0
Definition	Reserved	Reserved	Reserved	Reserved	Reserved	OPERATION_INIT		CAN_CTRL
Supported	NO	NO	NO	NO	NO	YES		NO

Low byte

Bit 1-2 OPERATION_INIT: 開機時OPERATION指令的預設值

00 = 開機設為00h: OFF

01 = 開機設為01h: ON

10 = 開機設為前一次的設定值

11 = 未使用

High byte:

Bit 10 EEP_OFF: 关闭电压电流参数写入EEPROM使能

0=电压电流参数实时写入EEPROM (默认)

1=电压电流参数禁止写入EEPROM

请参考6.4.4获取详细资讯

6.4 通訊範例

以下將提供CANBus協定讀與寫的範例

6.4.1 指令傳輸

主控端設定位址“03”單體的電壓為30V

CAN ID	DLC (data length)	Command code	Parameters
0xC0103	0x04	0x20 00	0xB80B

Command Code: 0x0020(Vout_Set) → 0x0020(Low)+0x00(High)

Parameters: 30V → 3000V → 0x0BB8 → 0xB8(Low)+0x0B(High)

Note: VOUT_SET轉換因數為0.01 · 所以 $\frac{30V}{F=0.01} = 3000$

6.4.2 讀取資料或狀況

主控端讀取定位址“03”單體的operation設定

CAN ID	DLC (data length)	Command code
0xC0103	0x02	0x00 00

位址“03”單體回傳如下：

CAN ID	DLC (data length)	Command code	Parameters
0xC0103	0x03	0x00 00	0x01

Parameters:0x01 ON,代表“03”號字體為operation ON.

6.4.3 通訊實務操作

因帶有通訊功能的NPB系列機型可以工作在充電器模式及電源供應器模式 (power supply mode)，故以NPB-450-48舉例，講述充電器模式下,將充電參數設定為CV: 60V; CC : 5A，充電器模式如何切換到電源供應器模式、電源供應器模式下輸出電壓設定為60V，輸出電流設定為5A。具體內容請詳見下方說明：

6.4.3.1 前期準備：

- ① 設定NPB-450的ID為03，即默認地址位，詳情請參考6.2章節說明。

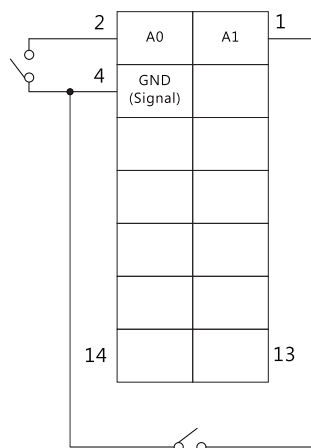

- ② 撥碼置於出廠狀態，需注意通過通訊設定之充電參數，僅適用於第一條曲線 (DIP2=OFF && DIP3=OFF)。

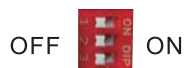

- ③ 連接控制器的CANH/CANL至該台NPB-450 CN71的CANH(PIN11)及CANL(PIN12)。建議系統通訊共地，讓訊號參考電平一致以增加通訊信賴度，即：連接CN71端子的GND_AUX(PIN9,PIN10任意之一或all)至系統的通訊GND。

- ◎ 設定baud rate:250Kbps,type:CAN 2.0B, extended;
- ◎ 控制器及NPB-450端各增加120Ω之終端電阻以增加通訊穩定性。

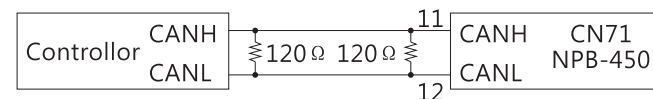

6.4.3.2 充電器模式下相關參數的設定介紹

- ① 設定Constant Voltage 為60V。

CAN ID	DLC (data length)	Command code	Parameters
0xC0103	0x04	0xB1 00	0x70 17

Command Code: 0x00B1 (CURVE_CV) → 0xB1(LO)+0x00(HT)
Parameters: 60V → 6000 → 0x1770 → 0x70(LO)+0x17(Hi)

Note:1. CURVE_CV 轉換因數為0.01，所以 $\frac{60V}{F=0.01} = 6000$

2. 充電相關參數之設定需重新AC上電或 remote on/off或通訊 operation on/off 後方可生效，並非立即生效。
3. NPB-450NFC機型2/3 stage 充电曲线设定仅能通过APP设定，且默认处于3stage；其余机型可通过拨码开关设定，默认处于3stage。

- ② 將Constant Current 設定為5A

CAN ID	DLC (data length)	Command code	Parameters
0xC0103	0x04	0xB0 00	0xF4 01

Command Code: 0x00B0 (CURVE_CC) → 0xB0(LO)+0x00(Hi)
Parameters: 5A → 500 → 0x01F4 → 0xF4(LO)+0x01(Hi)

Note:1. CURVE_CC 轉換因數為0.01，所以 $\frac{5A}{F=0.01} = 500$

2. 充電相關參數之設定需重新AC上電或 remote on/off或通訊 operation on/off 後方可生效，並非立即生效。

3. NPB-450NFC机型2/3 stage 充电曲线设定仅能通过APP设定，且默认处于3stage；其余机型可通过拨码开关设定，默认处于3stage。

6.4.3.3 由充電器模式切換到電源供應器模式

① 切換為VI mode (Power Supply mode)

此設定也需通過0x00B4(CURVE_CONFIG)進行設定，查手冊關於0X00B4相關說明可得，Low byte之Bit7=0時，NPB-450會切換至Power Supply mode。

即0x00 B4位址設定Parameters默認數值0x84 (請參考上文內容)之Bit7需改為0：1000 0100 → 0000 0100 → 0x04 (Low Byte)

即設定如下：

CAN ID	DLC (data length)	Command code	Parameters
0xC0103	0x04	0xB4 00	0x04 00

注：充電相關參數之設定需重新AC上電或 remote on/off或通訊 operation on/off 後方可生效，並非立即生效。

6.4.3.4 電源供應器模式下的相關設定介紹

① 設定輸出電壓為60V (VOUT_SET)

Command Code: 0x0020 (VOUT_SET) → 0x20(Lo)+0x00(Hi)

Parameters: 60V → 6000 → 0x1770 → 0x70(Lo)+0x17(Hi)

Note:1. VOUT_SET 轉換因數為0.01，所以 $\frac{60V}{F=0.01} = 6000$

2. VOUT_SET，IOUT_SET指令參數於發送後立即生效，斷電重啟或remote on/off或通訊operation on/off 後不保存當前參數，恢復為默認數值。

② 設定輸出電流為5A (IOUT_SET)

CAN ID	DLC (data length)	Command code	Parameters
0xC0103	0x04	0x30 00	0xF4 00

Command Code: 0x003 (IOUT_SET) → 0x30(Lo)+0x00(Hi)

Parameters: 5A → 500 → 0x01F4 → 0xF4(Lo)+0x01(Hi)

Note:1. IOUT_SET 轉換因數為0.01，所以 $\frac{5A}{F=0.01} = 500$

2. VOUT_SET，IOUT_SET指令參數於發送後立即生效，斷電重啟或remote on/off或通訊operation on/off 後不保存當前參數，恢復為默認數值。

6.4.4 注意事項

- 充電器模式下，如下指令會失效：

0x0020	VOUT_SET	R/W	2	輸出電壓設定 (format: value, F=0.01)
0x0030	IOUT_SET	R/W	2	輸出電流設定 (format: value, F=0.01)

- 電源供應器模式下，如下指令會失效：

0x00B0	CURVE_CC	R/W	2	充電曲線定電流 (format: value, F=0.01)
0x00B1	CURVE_CV	R/W	2	充電曲線定電壓 (format: value, F=0.01)
0x00B2	CURVE_FV	R/W	2	充電曲線浮充電壓 (format: value, F=0.01)
0x00B3	CURVE_TC	R/W	2	充電曲線轉態電流 (format: value, F=0.01)
0x00B4	CURVE_CONFIG	R/W	2	充電器功能
0x00B5	CURVE_CC_TIMEOUT	R/W	2	充電曲線定電流充電計時
0x00B6	CURVE_CV_TIMEOUT	R/W	2	充電曲線定電壓充電計時
0x00B7	CURVE_FV_TIMEOUT	R/W	2	充電曲線浮充電計時
0x00B8	CHG_STATUS	R	2	充電器狀態
0x00B9	CHG_RST_VBAT	R/W	2	充飽後重啟充電的 電壓點設定

- 充電器模式下，僅第一條充電曲線是可以通過通訊調整相關數值 (DIP 2=OFF && DIP 3=OFF)

- EEP_OFF说明：
 - 1.当SYSTEM_CONFIG High Byte之Bit 10 EEP_OFF为0 (默认值) 时：0xB0~B3、0xB9、0x20、0x30这7个指令实时写入EEPROM中；
 - 2.当SYSTEM_CONFIG High Byte之Bit 10 EEP_OFF为1时：0xB0~B3、0xB9、0x20、0x30这7个指令不会写入到EEPROM中；
- 充电器模式下，0xB0~B3、0xB9(CC、CV、FV、TC、CHG_RST_VBAT)这5个参数在remote off时会即时生效，而在remote on时不会即时生效；
- 电源供应器模式下，0x20、0x30(VOUT_SET、IOUT_SET)指令会即时生效；
- Remote off可清除BAT_NC、BAT_OVP、Vo_FOVP (浮动OVP)、OLP四种由韧体根据通讯参数判定的保护，硬件remote off可起到相同功能；
- 当EEPROM error触发时，可通过恢复出厂进行清除；
- NPB可透過0x00B9 (CHG_RST_VBAT) 指令設定NPB充飽電後自動重新進行充電流程的電壓點 (AC無需重啟，且不需要remote on/off或通訊operation on/off)。需滿足如下兩個條件，該功能才會生效：
 - ◎ NPB處於曲線充電模式，並且該設定值適用於全部4條充電曲線；
 - ◎ 0x00B4(CURVE_CONFIG) High byte之bit3: RSTE的值为1。
 舉例來說：
 將NPB-450-48的0x00B9 (CHG_RST_VBAT) 的值設定為54V，且0x00B4(CURVE_CONFIG) High byte之bit3: RSTE的值为1；此時，NPB-450-48輸出接電池且電池充滿電後，當電池電壓掉到54V，NPB-450-48會自動從CC階段開始給電池充電；

6.4.5 充電器模式與電源供應器模式比較

	充電器模式 (出廠設定)	電源模式
充電控制	充電過程由充電器依預設的充電曲線自動控制	恆壓輸出 輸出電壓和電流可透過CANBus即時控制
過載保護點	$I_o > I_{set} * 95\%$ $V_o < 55\% * V_{boost_default}$	$I_o > I_{set} * 95\%$ $V_o < V_{set} * 77\%$

	充電器模式 (出廠設定)	電源模式
適用的CAN Bus 指令	ON/OFF控制、 CURVE_CONFIG、 監控指令集	ON/OFF控制、 VOUT/IOUT_SET、 監控指令集
模式設定方式	通訊設定CURVE_CONFIG 低byte 位元7至1 (出廠設定值)	通訊設定CURVE_CONFIG 低byte 位元7至0

6.5 CANBus數值範圍與誤差

- 顯示參數

CANBus Command		機型	顯示數值範圍	顯示誤差	
0x0050	READ_VIN	ALL	80 ~ 264V	±10V	
0x0060	READ_VOUT	12V	0 ~ 21V	±0.12V	
		24V	0 ~ 42V	±0.24V	
		48V	0 ~ 80V	±0.48V	
		72V	0 ~ 100V	±0.60V	
0x0061	READ_IOUT (Note)	NPB-1700	12V	0 ~ 102A	±0.85A
			24V	0 ~ 60A	±0.50A
			48V	0 ~ 30A	±0.25A
		NPB-1200	12V	0 ~ 84A	±0.70A
			24V	0 ~ 43A	±0.36A
			48V	0 ~ 22A	±0.18A
		NPB-750	12V	0 ~ 52A	±0.43A
			24V	0 ~ 27A	±0.23A
			48V	0 ~ 14A	±0.11A

CANBus Command		機型		顯示數值範圍	顯示誤差
0x0061	READ_IOUT (Note)	NPB-450/450NFC	12V	0 ~ 30A	±0.25A
			24V	0 ~ 16A	±0.14A
			48V	0 ~ 8A	±0.07A
			72V	0 ~ 5.5A	±0.06A
0x0062	READ_TEMPERATURE_1	ALL		-40 ~ 110°C	±5°C

● 控制參數

CANBus Command		機型	可控制數值範圍	控制誤差	預設值	
0x0000	OPERATION	ALL	00h(OFF)/ 01h(ON)	N/A	01h (ON)	
0x0020	VOUT_SET	12V	10.5 ~ 21V	±0.12V	0V	
		24V	21 ~ 42V	±0.24V	0V	
		48V	42 ~ 80V	±0.48V	0V	
		72V	54 ~ 100V	±0.60V	0V	
0x00B1	CURVE_VBST	12V	10.5 ~ 21V	±0.12V	14.4V	
		24V	21 ~ 42V	±0.24V	28.8V	
		48V	42 ~ 80V	±0.48V	57.6V	
		72V	54 ~ 100V	±0.60V	72V	
0x00B2	CURVE_VFLOAT	12V	10.5 ~ VBST	±0.12V	13.8V	
		24V	21 ~ VBST	±0.24V	27.6V	
		48V	42 ~ VBST	±0.48V	55.2V	
		72V	54 ~ VBST	±0.60V	69V	
0x0030	IOUT_SET	NPB-1700	12V	17 ~ 85A	±0.85A	85A
			24V	10 ~ 50A	±0.50A	50A
			48V	5 ~ 25A	±0.25A	25A
		NPB-1200	12V	14 ~ 70A	±0.70A	70A
			24V	7.2 ~ 36A	±0.36A	36A
			48V	3.6 ~ 18A	±0.18A	18A

CANBus Command		機型	可控制數值範圍	控制誤差	預設值		
0x0030	IOUT_SET	NPB-750	12V	8.6 ~ 43A	±0.43A	43A	
			24V	4.5 ~ 22.5A	±0.23A	22.5A	
			48V	2.26 ~ 11.3A	±0.11A	11.3A	
		NPB-450/ 450NFC	12V	5 ~ 25A	±0.25A	25A	
			24V	2.7 ~ 13.5A	±0.14A	13.5A	
			48V	1.36 ~ 6.8A	±0.07A	6.8A	
0x00B0	CURVE_ICHG	NPB-1700	12V	17 ~ 85A	±0.85A	85A	
			24V	10 ~ 50A	±0.50A	50A	
			48V	5 ~ 25A	±0.25A	25A	
		NPB-1200	12V	14 ~ 70A	±0.70A	70A	
			24V	7.2 ~ 36A	±0.36A	36A	
			48V	3.6 ~ 18A	±0.18A	18A	
			NPB-750	12V	8.6 ~ 43A	±0.43A	43A
		24V		4.5 ~ 22.5A	±0.23A	22.5A	
		48V		2.26 ~ 11.3A	±0.11A	11.3A	
		NPB-450/ 450NFC		12V	5 ~ 25A	±0.25A	25A
				24V	2.7 ~ 13.5A	±0.14A	13.5A
			48V	1.36 ~ 6.8A	±0.07A	6.8A	
72V	1.1 ~ 5.5A		±0.06A	5.5A			
0x00B3	CURVE_ITAPER	NPB-1700	12V	1.7 ~ 25.5A	±0.85A	8.5A	
			24V	1 ~ 15A	±0.50A	5A	
			48V	0.5 ~ 7.5A	±0.25A	2.5A	

CANBus Command		機型	可控制數值範圍	控制誤差	預設值	
0x00B3	CURVE_ ITAPER	NPB-1200	12V	1.4 ~ 21A	±0.70A	7A
			24V	0.72 ~ 10.8A	±0.36A	3.6A
			48V	0.36 ~ 5.4A	±0.18A	1.8A
		NPB-750	12V	0.86 ~ 12.9A	±0.43A	4.3A
			24V	0.45 ~ 6.75A	±0.23A	2.25A
			48V	0.23 ~ 3.39A	±0.11A	1.13A
0x00B3	CURVE_ ITAPER	NPB-450/ 450NFC	12V	0.5 ~ 7.5A	±0.25A	2.5A
			24V	0.27 ~ 4.05A	±0.14A	1.35A
			48V	0.14 ~ 2.04A	±0.07A	0.68A
			72V	0.11 ~ 1.65A	±0.06A	0.55A
0x00B4	CURVE_ CONFIG	ALL	N/A	N/A	0004h	
0x00B5	CURVE_CC_ TIMEOUT	ALL	60 ~ 64800 minute	±5 minute	600 minute	
0x00B6	CURVE_CV_ TIMEOUT					
0x00B7	CURVE_FLOAT_ TIMEOUT					
0x00B9	CHG_RST_ VBAT	12V	10.5~21V	±0.12V	13.2V	
		24V	21~42V	±0.24V	26.4V	
		48V	42~80V	±0.48V	52.8V	
		72V	54~100V	±0.6V	66V	
0x00C2	SYSTEM_ CONFIG	ALL	N/A	N/A	03h	

NOTE: 當輸出電流小於下表所列數值時，READ_IOUT讀值將顯示為0A。

機型	最小顯示電流	
NPB-1700	12V	0.85A±0.85A
	24V	0.5A±0.5A
	48V	0.25A±0.25A
NPB-1200	12V	0.7A±0.7A
	24V	0.36A±0.36A
NPB-750	48V	0.18A±0.18A
	12V	0.43A±0.43A
NPB-450/450NFC	24V	0.23A±0.23A
	48V	0.11A±0.11A
	72V	0.06A±0.06A

7.NPB-450-XXNFC APP操作說明

NPB-450 系列NFC版本充電器可使用具有NFC功能的智慧裝置透過APP設定充電曲線等相關參數，使用說明及注意事項請參考下文所述。

7.1 使用前準備

手機或移動裝置需具支援NFC功能並且安裝有MEAN WELL APP應用程式，如果尚未在移動裝置上安裝該應用程式，請掃描下載：



7.2 相容的手機或移動裝置

Android: Android 作業系統4.1(API 16)及以上版本且帶有NFC功能的智慧手機或裝置
 iPhone: IOS 12及以上版本的iPhone

7.3 設定步驟

- ① 移動裝置或手機請先下載明緯APP，並開啟NFC功能。
- ② 請先確認手機NFC天線位置，需將手機天線靠近NPB側板感應區 (<5公分)。
 - iPhone: NFC天線位於手機背面正上方位置
 - Android: NFC天線位於手機背面中心位置
 - 如果無法感應，請參考手機使用手冊。

- ③ 點選明緯APP→左上角選單→安裝手冊/APP→Power NFC，點選NFC並靠近充電器NFC感應位置進行讀取。



- ④ 感應成功後APP會顯示功能參數，可依您需求調整相關充電參數。
- ⑤ 點按“設定”按鈕更新充電參數。
- ⑥ 將手機天線再次靠近充電器NFC感應位置後，點選APP寫入鍵進行燒錄，成功後手機會以聲音或震動提醒。
- ⑦ 完成燒錄。

注：完成上述步驟1~7設定後，再次重複步驟3~4即可讀取並確認調整後的充電器是否已如實完成參數修改。

7.4 APP功能說明

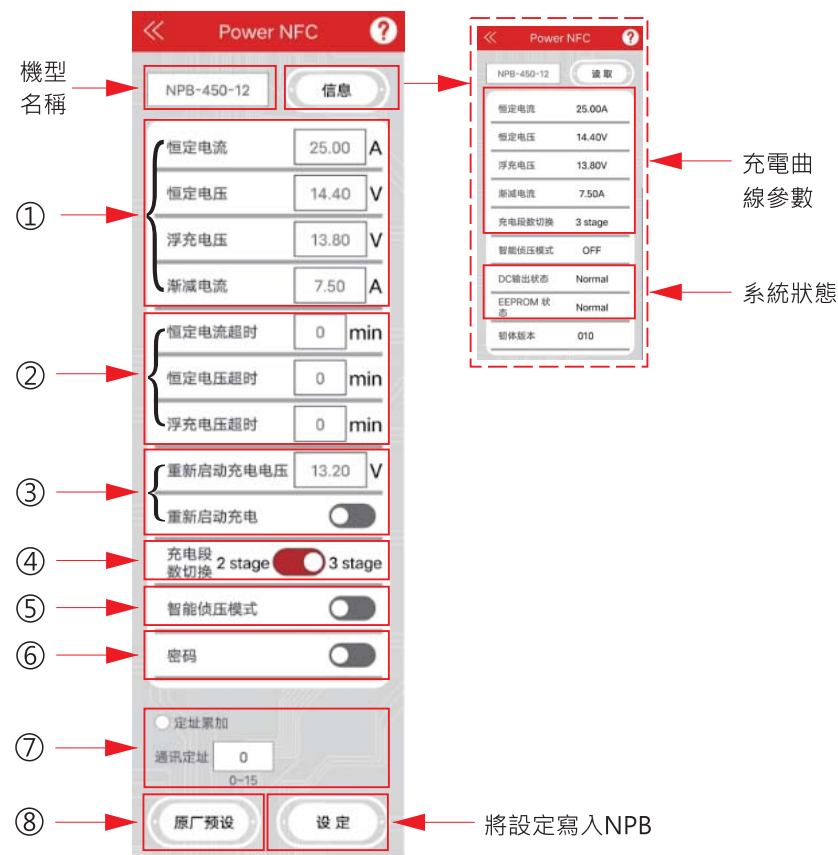

- ① 充電曲線可調：此4項為NPB充電CC、CV、FV、TC設定值，可對此處參數進行修改，滿足實際充電要求
- ② 調整曲線充電的超時時間：此3項為NPB使用曲線充電時，CC、CV、FV階段的充電超時保護時間，當設置為“0”時，關閉充電超時保護功能，設置為“1~6000”時，分別對應超時保護時間為1~6000分鐘。

③ 充飽後重啟充電的電壓點設定ON/OFF選擇：

在重新開啟充電功能按鈕處於ON狀態時，在充電完成後，當電池電壓跌落到重新開啟充電設定電壓值後，NPB會從CC 階段重啟充電進程；此電壓值可根據實際應用情況進行設定，必須低於浮充電壓設定值。

④ 可選擇2或3段式充電：

此處按鈕可設定2段式或3段式充電

⑤ 智能偵壓充電模式ON/OFF選擇：

此處按鈕處於ON狀態時，可開啟智慧偵壓模式，充電器會偵測電池電壓，關於智慧偵壓模式的詳細說明請參考NPB手冊37頁相關內容；若處於OFF狀態，即處於曲線充電模式，此時充電參數的設定生效。

⑥ NFC燒錄密碼設定：

出廠時並未設定密碼，使用者可自行設定，密碼最多可設定為8位元，字元需為數字或英文字母（區分大小寫），不可為特殊字元；密碼設定成功後，後續燒錄操作前需輸入密碼。

⑦ CANBus通訊地址設定：

預設通訊位址為0x00；
可設定NPB機型的通訊位址，設定後最多可支援16台設備進行CANBus多機通訊，可設定位址0~15（0x00~0x0F）；
當定址累加功能處於ON狀態時，後續燒錄的NPB 機型通訊位址會依次累加。

⑧ 返回出廠設定：

點擊原廠預設按鈕，可將NPB相關參數恢復到出廠設定；
燒錄按鈕是每次設定參數後進行燒錄的必要操作。

註：1. 詳細功能與參數說明請參考NPB手冊38~42頁。

2. 智能偵壓僅限用內建BMS(電池管理系統)之鋰電池。

7.5 NFC使用注意事項

- 讀取及燒錄參數時有無接AC電力均可，帶電燒錄參數不會即時生效，需斷電重啟才能生效。
- 若忘記燒錄密碼，可通過硬體方式恢復出廠設定來重置密碼，具體設定方式請參考5.5章關於恢復原廠設定的說明。

7.6 APP常見問題

狀態	排除方法
<p>APP提示當前NFC關閉</p> 	<p>請在手機或智慧裝置設置中先打開NFC功能，並重新打開APP</p>
<p>APP提示‘無法辨識的機型名稱’或‘設定失敗’</p> 	<p>請確認NFC天線位置，需縮短感應距離<5cm內，重新按照62頁設定步驟重新進行操作</p>
<p>APP提示‘手機NFC不可使用’</p> 	<p>請更換支援NFC功能的手機或智慧裝置後再次嘗試</p>

8.保護功能及異常排除

8.1 保護功能

8.1.1 輸入低壓保護(NPB-750/1200/1700)

當輸入電壓過低時，輸入低壓保護線路會啟動，充電器即會關閉輸出。當輸入電壓回復正常時，充電器會自行重啟輸出。

8.1.2 輸出過電壓保護(所有系列)

當輸出電壓過高時，輸出過壓保護線路會啟動。當過壓狀態解除後，需重新啟動方能使充電器回復正常工作狀態。

8.1.3 短路保護(所有系列)

當輸出端短路時，此充電器會以恆定電流方式限制其輸出，並於5秒後關機保護。排除短路後需重新開機，始可恢復正常輸出。

8.1.4 電池電壓過低與過高保護(NPB-450/450NFC/750/1200/1700)

當連接的電池電壓過低時(8V(12V model)/16V(24V model)/32V(48V model)/40V(72V model))，充電器將不會輸出電流並關閉輸出，以防止錯誤電壓充電造成電池損壞。當連接的電池電壓過高時(21V(12V model)/42V(24V model)/80V(48V model)/100V(72V model))，充電器將不會動作，以保護相關電路。連接正確電池後需重新開機，始可恢復正常輸出。

8.1.5 過溫度保護(所有系列)

當充電器內部溫度過高時，充電器將會自動關閉輸出。當溫度恢復正常後充電器會自動重啟工作。

8.1.6 反極性保護(NPB-120/240/360/450/450NFC/750/1200/1700)

NPB-120/240/360內建保險絲與逆接二極體，當電池反接時充電器輸出呈現關斷狀態，內建保險絲會熔斷。

NPB-450/450NFC/750/1200/1700內建電池反接偵測電路，當電池反接時充電器輸出呈現關斷狀態，充電器不會損壞。

8.2 異常排除

狀態	可能原因	排除方法
充電器未充電	充電器Power OFF	請Power ON後重試
	充電器Remote OFF	請確認Remote ON/OFF接至+12Vaux後重試
電池長時間充電仍無法充飽	電池已老化或損壞	更換新電池
	輸出線材線徑太細	選擇適當線徑之線材
	充電曲線設定錯誤	重新確認電池充電曲線
充電器燈號顯示為異常狀態	環境溫度過高	待降低環境溫度後重新開機測試
	鋰電BMS(電池管理系統)造成充電器判斷異常	聯絡電池原廠確認BMS相關規格
	電池電壓不匹配	確認充電器與電池規格是否可以搭配使用
	電池偵測異常	確認電池狀態是否正常

若仍無法排除故障情形，請洽明緯或明緯經銷商

9.保固

本產品符合規格條件下，可提供3年之無償免費維修服務。請勿自行更換零件或對本產品進行任何形式的修改或維修，以免影響您享有正常保固服務之權利。

※明緯保有修訂使用手冊之權利，若有修訂，請以明緯
官網資訊為準。 <https://www.meanwell.com>



10.環境宣告資訊

https://www.meanwell.com//Upload/PDF/RoHS_PFOS.pdf
https://www.meanwell.com//Upload/PDF/REACH_SVHC.pdf
https://www.meanwell.com//Upload/PDF/Declaration_RoHS-C.pdf

明緯企業股份有限公司

MEAN WELL ENTERPRISES CO., LTD.

248 新北市五股區五權三路28號

No.28, Wuquan 3rd Rd., Wugu Dist., New Taipei City 248, Taiwan

Tel: 886-2-2299-6100 Fax: 886-2-2299-6200

<http://www.meanwell.com> E-mail: info@meanwell.com