

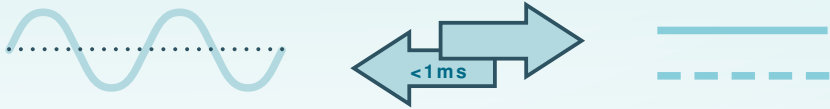

# BIC-2200 Series

## Installation manual



### *Bidirectional Power Supply*

• High efficiency • Lightweight • Intelligent

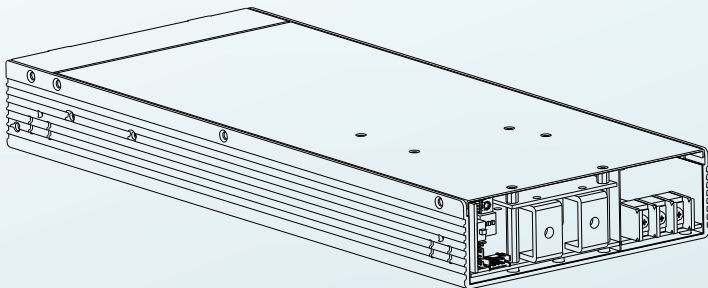

The BIC-2200 is a 2.2KW bidirectional power supply with energy recycle function. It is fully digital and 1U height designed. It is designed to control the power transferred from AC grid to DC and DC to AC grid for energy recycle. The implementation of a bidirectional power supply of the BIC-2200 allows battery manufactures to charge the battery from AC grid and recycle the DC energy back into AC grid in one single unit. With built-in functions such as active current sharing, remote ON/OFF control and CANBus model available, the BIC-2200 provides vast design flexibility for battery formation & test equipment, V2G(Vehicle-to-grid) system, charging station, laser system and kinetic recovery system.

# Contents

<b>1.Safety Guidelines</b>	1	<b>6.Protections and Trouble Shooting</b>	38
<b>2.Introduction</b>	2	6.1 Protections	38
2.1 Model Encoding	2	6.2 Trouble Shooting	39
2.2 Features	2	<b>7.Warranty</b>	40
2.3 Specification	3	<b>8.Environmental declaration information</b>	40
2.4 Derating curve	5		
2.5 Mechanical specification	6		
<b>3.Installation &amp; Wiring</b>	7		
3.1 Precautions	7		
3.2 Installation Procedures	7		
3.3 DC Cable Size Selection	8		
<b>4.User Interface</b>	9		
4.1 Panel Description	9		
4.2 LED Indicator	10		
4.3 Pin Assignment of CN46	10		
4.4 Pin Assignment of CN47	12		
4.5 Function Description of SW50	12		
4.6 Function Description of DIP Switch	13		
<b>5.Operation</b>	14		
5.1 Description of Bidirectional Operation	14		
5.2 Inrush Current Limiting	19		
5.3 Power Factor Correction (PFC)	19		
5.4 Fan Speed control	19		
5.5 Fault Signal	20		
5.6 ( $\overline{\text{DC-OK}}$ ) Signal	20		
5.7 Remote Control	20		
5.8 Auxiliary Output	21		
5.9 Parallel Operation	21		
5.10 CANBus Protocol	22		
5.11 Restore Factory Default Setting	37		

## 1.Safety Guidelines

- Risk of electrical shock and energy hazard, all failure should be examined by a qualified technician. Please do not remove the case form the bidirectional power supply by yourself.
- Please do not install the supply in places with high moisture, high ambient temperature or under direct sunlight.
- The AC voltage range is 180 – 260Vac (47 – 63Hz), please do not connect the supply to AC gird out of the range.
- Fans and ventilation holes must be kept free from any obstructions. At least 15 cm clearance must be kept when the adjacent device is a heat source.
- Please do not stack any object on the unit.
- The safety protection level of this supply is class I. The “Frame Ground”(⚡) of the unit must be well connected to PE (Protective Earth).
- BIC-2200 should be installed in al pollution degree 2 environment.
- Icc=7.5kA ; Icp, mr=200A.

## 2.Introduction

### 2.1 Model Encoding

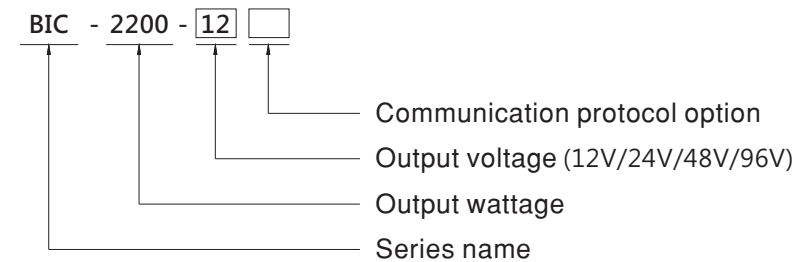

Type	Communication Protocol	Note
Blank	None protocol	In Stock
CAN	CANBus protocol	In Stock

### 2.2 Features

- 1U low profile design
- Full digital design with 93% conversion efficiency for both AC/DC and DC/AC conversion
- Ultrafast switching time between AC/DC and DC/AC of 1ms
- CB/TUV/UL 62368-1 and CB/TUV 62477-1 certified
- Active current sharing up to 11000W(4+1)
- <3% Low THDi in both conversion mod
- Force charging and discharging mode with CANBus model
- Complete protections: Anti-islanding protection, AC fail protection, DC OVP,OLP, OCP, OTP
- 5 years warranty

## 2.3 Specification

MODEL		BIC-2200-12	BIC-2200-24	BIC-2200-48	BIC-2200-96	
AC to DC Direction	OUTPUT	DC VOLTAGE	12V	24V	48V	96V
		RATED CURRENT	180A	90A	45A	22.5A
		RATED POWER	2160W			
		FULL POWER VOLTAGE RANGE	12 ~ 15V	24 ~ 28V	48 ~ 65V	96 ~ 112V
		RIPPLE & NOISE (max.) <small>Note.2</small>	160mVp-p	260mVp-p	300mVp-p	480mVp-p
		VOLTAGE ADJ. RANGE	10 ~ 15V	19 ~ 28V	38 ~ 65V	76 ~ 112V
		CURRENT ADJ. RANGE	0 ~ 180A	0 ~ 90A	0 ~ 45A	0 ~ 22.5A
		VOLTAGE TOLERANCE <small>Note.3</small>	±1.0%	±1.0%	±1.0%	±1.0%
		LINE REGULATION	±0.5%	±0.5%	±0.5%	±0.5%
		LOAD REGULATION	±0.5%	±0.5%	±0.5%	±0.5%
	SETUP, RISE TIME	1800ms, 60ms/230VAC at full load				
	INPUT	AC VOLTAGE RANGE	180 ~ 264VAC			
		FREQUENCY RANGE	47 ~ 63Hz			
		POWER FACTOR (Typ.)	0.98/230VAC at full load			
EFFICIENCY (Typ.) <small>Note.5</small>		90%	93%	93%	93%	
AC CURRENT (Typ.)		11A/230VAC				
INRUSH CURRENT (Typ.)		COLD START 35A/230VAC				
LEAKAGE CURRENT		<2mA/230VAC				
TOTAL HARMONIC DISTORTION		<3% (@load=100%/230VAC)				
DC to AC Direction	INPUT (Note.4)	RATED INPUT POWER	1800W			
		FULL POWER VOLTAGE RANGE	12 ~ 15V	24 ~ 28V	48 ~ 65V	96 ~ 112V
		DC VOLTAGE RANGE	10 ~ 15V	19 ~ 28V	38 ~ 65V	76 ~ 112V
		MAX. INPUT CURRENT	150A	75A	37.5A	18.75A
		OUTPUT POWER (Typ.) (@240V)	1685W	1720W	1720W	1685W
	OUTPUT	VOLTAGE RANGE	180 ~ 264VAC determined by AC main			
		FREQUENCY RANGE	47 ~ 63Hz determined by AC main			
		AC CURRENT (Typ.)	7.5A/230VAC			
		POWER FACTOR (Typ.)	0.99/230VAC at full load			
		EFFICIENCY (Typ.) <small>Note.5</small>	90.5%	93%	93%	93%
PROTECTION	OVER LOAD	105 ~ 115% rated output power				
		AC to DC	Constant current limiting, shut down DC O/P voltage 5 sec. after DC O/P voltage is down low, re-power on to recover			
	SHORT CIRCUIT	Shut down O/P current, re-power on to recover				
		DC to AC	Not accurable with constant power design			
	OVER VOLTAGE	17.6 ~ 20.8V	33.6 ~ 39.2V	72.6 ~ 86V	134 ~ 157V	
	OVER TEMPERATURE	Shut down O/P voltage, recovers automatically after temperature goes down				
ISLANDING PROTECTION	Shut down AC O/P voltage, re-power on to recover					
FUNCTION	REMOTE ON-OFF CONTROL	By electrical signal or dry contact Short: Power ON Open: Power OFF Please refer to the Function Manual infollowing				
	BIDIRECTION SWITCH TIME(Typ.)	1ms				
	ALARM SIGNAL	Isolated TTL signal output for T-Alarm, DC-OK and Fault Please refer to the Function Manual in following pages				
	AUXILIARY POWER	12V@0.5A tolerance ±5%, ripple 150mVp-p				
	BATTERY MODE RATED CURRENT(default) <small>Note.7</small>	AC to DC	160A	80A	40A	20A
DC to AC		120A	64A	32A	16A	
		Can be adjusted by communication				

MODEL		BIC-2200-12	BIC-2200-24	BIC-2200-48	BIC-2200-96	
ENVIRONMENT	WORKING TEMP.	-30 ~ +70°C (Refer to "Derating Curve")				
	WORKING HUMIDITY	20 ~ 90% RH non-condensing				
	STORAGE TEMP., HUMIDITY	-40 ~ +85°C, 10 ~ 95% RH non-condensing				
	TEMP. COEFFICIENT	±0.03%/°C (0 ~ 45°C)				
	VIBRATION	10 ~ 500Hz, 2G 10min./1cycle, 60min. each along X, Y, Z axes				
SAFETY & EMC	SAFETY STANDARDS	UL62368-1, IEC62368-1, CAN/CSA C22.2 No.62368-1,TUV BS EN/EN62368-1, EAC TP TC 004, IEC62477-1, TUV BS EN/EN62477-1 approved				
	WITHSTAND VOLTAGE <small>Note.8</small>	I/P-O/P:3KVAC I/P-FG:2KVAC O/P-FG:500VAC				
	ISOLATION RESISTANCE <small>Note.8</small>	I/P-O/P, I/P-FG, O/P-FG:100M Ohms / 500VDC / 25°C / 70% RH				
	EMC EMISSION	BS EN/EN55032				
		Parameter	Standard	Test Level / Note		
		Conducted	BS EN/EN55032 (CISPR32)		Class A	
		Radiated	BS EN/EN55032 (CISPR32)		Class A	
		Harmonic Current	BS EN/EN1000-3-2		Class A	
	Voltage Flicker	BS EN/EN61000-3-3		-----		
	EMC IMMUNITY	BS EN/EN55035, BS EN/EN61000-6-2				
Parameter		Standard	Test Level / Note			
ESD		BS EN/EN61000-4-2		Level 3, 8KV air ; Level 2, 4KV contact		
Radiated		BS EN/EN61000-4-3		Level 3		
EFT / Burst		BS EN/EN61000-4-4		Level 3		
Surge		BS EN/EN61000-6-2		2KV/Line-Line 4KV/Line-Earth		
Conducted		BS EN/EN61000-4-6		Level 3		
Magnetic Field		BS EN/EN61000-4-8		Level 4		
Voltage Dips and Interruptions		BS EN/EN61000-4-11		>95% dip 0.5 periods, 30% dip 25 periods, >95% interruptions 250 periods		
OTHERS		MTBF	462.9K hrs min.	Telcordia SR-332 (Bellcore) ; 46K hrs min.	MIL-HDBK-217F (25°C)	
	DIMENSION	330*140*41mm (L*W*H)				
	PACKING	2.9Kg; 4pcs/12.6Kg/1.25CUFT				
NOTE	<p>1. All parameters NOT specially mentioned are measured at 230VAC input, rated load and 25°C of ambient temperature.</p> <p>2. Ripple &amp; noise are measured at 20MHz of bandwidth by using a 12" twisted pair-wire terminated with a 0.1uf &amp; 47uf parallel capacitor.</p> <p>3. Tolerance : includes set up tolerance, line regulation and load regulation.</p> <p>4. As a constant power output, the driver will auto derating the current limitation when voltage raise above rated voltage(12V,24V,48V,96V) in order to remain 1800W output. On the other hand, when voltage is below rated voltage(12V,24V,48V,96V), the maximum current limitation will set at Max input current.</p> <p>5. The efficiency is measured at 75% load.</p> <p>6. The ambient temperature derating of 5°C/1000m with fan models for operating altitude higher than 2000m(6500ft).</p> <p>7. CANBus model only.</p> <p>8. During withstands voltage and isolation resistance testing, the screw "A" shall be temporarily removed, and shall be installed back after the testing.</p> <p>※ Product Liability Disclaimer : For detailed information, please refer to <a href="https://www.meanwell.com/serviceDisclaimer.aspx">https://www.meanwell.com/serviceDisclaimer.aspx</a></p>					

## 2.4 Derating curve

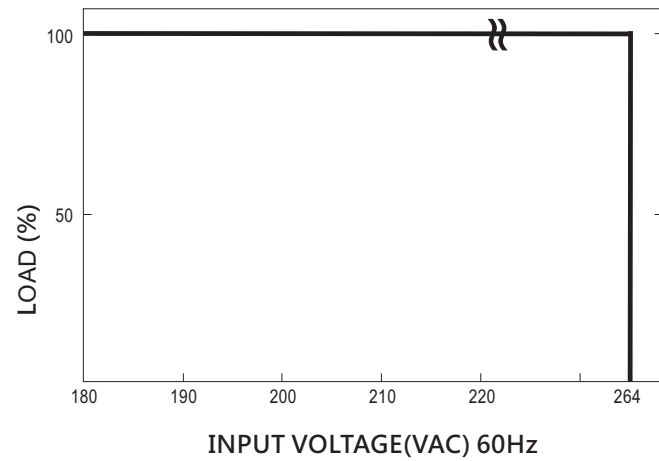
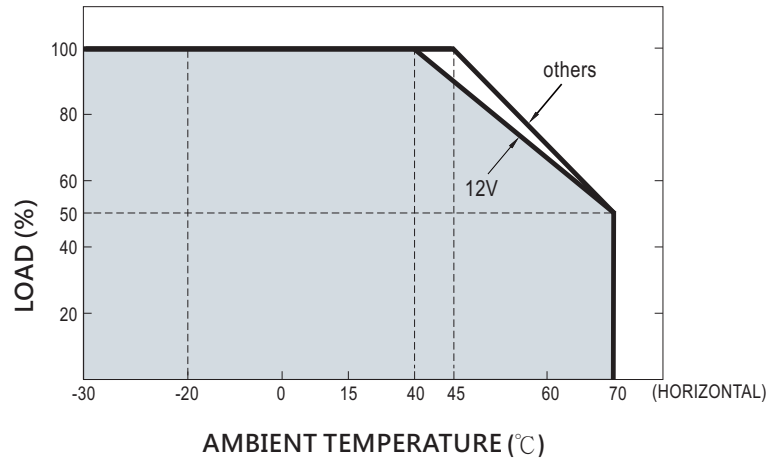

## 2.5 Mechanical specification

Unit:mm

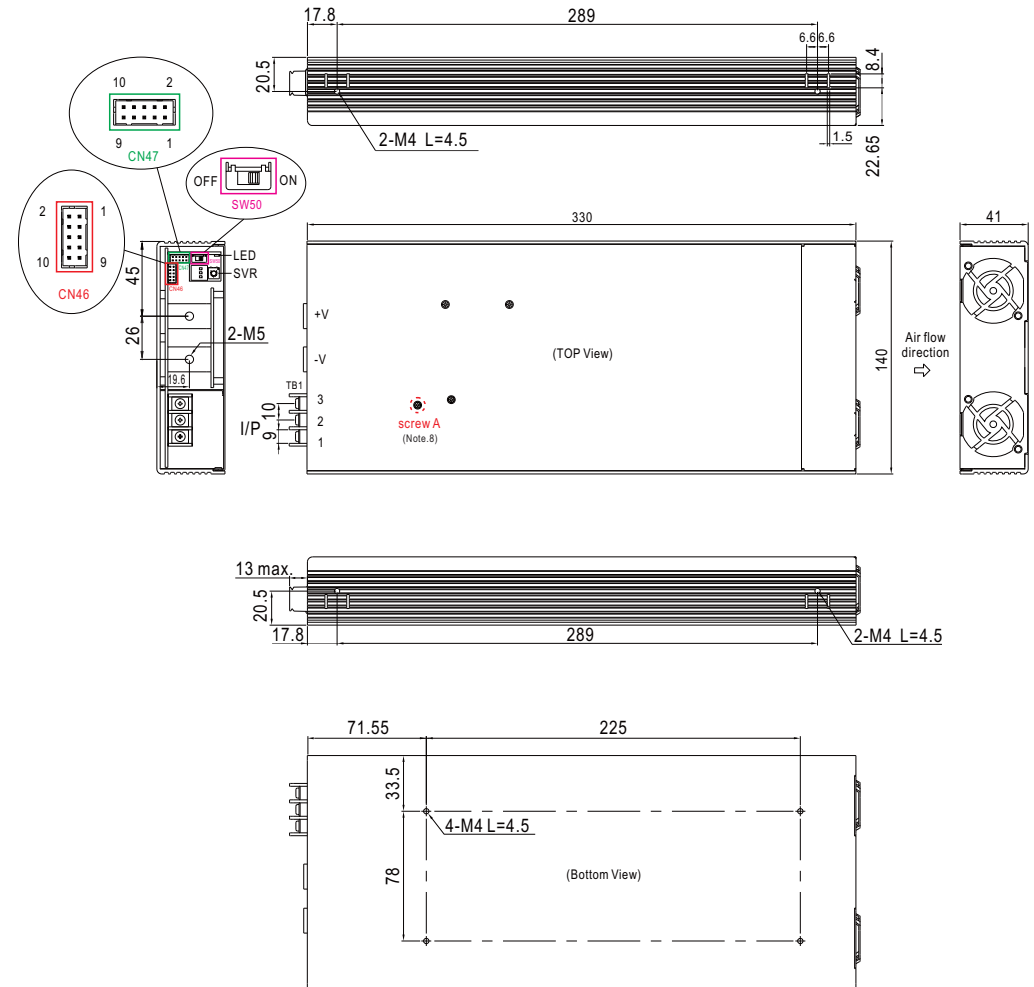

## 3. Installation & Wiring

### 3.1 Precautions

- Please make sure the system chassis has sufficient strength to carry the unit.
- In order to ensure the lifespan of the unit, you should refrain from operating the unit in environment of high dust or moisture.
- The bidirectional power supply is designed with built-in DC fans, please make sure the ventilation is not blocked. There should be no barriers within 15cm of the ventilating

### 3.2 Installation Procedures

- ① Choose the right and suitable cable size for connection between the BIC-2200 and the loads or batteries. Please refer to 3.3 DC cable size selection.
- ② Connect the DC positive polarity of the supply to the positive of the loads/batteries and connect the DC negative polarity of the supply to the negative of the loads/batteries. Make sure there is no reverse polarity or short-circuit on the connection.

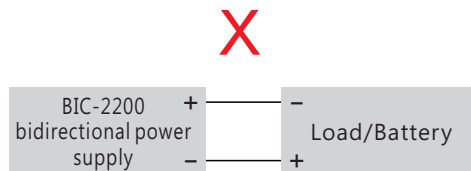
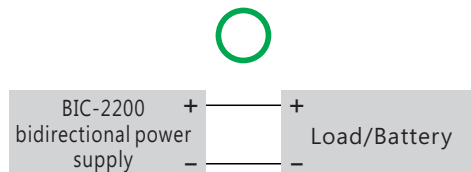

- ③ Connect the supply to the AC grid, FG to the earth, AC/N to the neutral and AC/L to the live.

NOTE: The bidirectional power supply is single-phase input/output. Please pay attention to the wiring when connecting the supply to a three-phase system.

### 3.3 DC Cable Size Selection

Wire connections should be as short as possible and less than 1 meter is highly recommended. Make sure that suitable wires are chosen based on safety requirement and rating of current. Small cross section will result in lower efficiency, less output power and the wires may also become overheated and cause danger. For selection, please refer to table 3-1.

AWG	Cross-section Are(mm <sup>2</sup> )	DC current (A)
8	6	32A ~ 40A
6	10	40A ~ 63A
4	16	63A ~ 80A
2	25	80A ~ 100A
1	35	100A ~ 125A
---	30	139A
---	50	190A
---	60	217A
---	80	257A

Table 3-1 Wire recommendations

## 4. User Interface

### 4.1 Panel Description

- Ⓐ **Ventilation holes for fans:**  
The supply requires suitable ventilation to work properly. Please make sure there is sufficient ventilation and the lifespan of the supply can be preserved.
- Ⓑ **LED indicator:**  
Indicate the status of supply and the load condition.
- Ⓒ **SVR:**  
For DC voltage setting.
- Ⓓ **DIP switch:**  
For device addressing when using the communication interface.
- Ⓔ **SW50:**  
Used to stabilize parallel signals when multi-supplies in parallel connection.
- Ⓕ **Function pins:**  
They are used for control and monitoring functions. Please refer to 4.3 and 4.4.
- Ⓖ **DC terminals**
- Ⓗ **AC terminals**

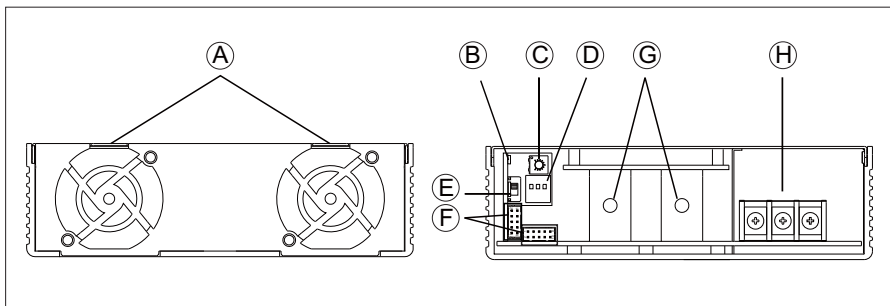

### 4.2 LED Indicator

The LED indicator is controlled by the microcontroller or the MCU. The MCU will change color of the indicator according to its operation status. The indicator lights in constant green when the supply is in operating mode; The indicator's flashing in green when the supply is in recycle mode; The indicator turns red when the supply is in abnormal conditions or protection mode.

LED Indicator	Status
● Green	Operating (AC to DC, work as an ordinary power supply or charger)
⚡ Green (Flashing)	Recycle (DC to AC, work as a grid tie inverter)
● Red	Abnormal (OTP, OLP, fan-lock, etc...)

### 4.3 Pin Assignment of CN46

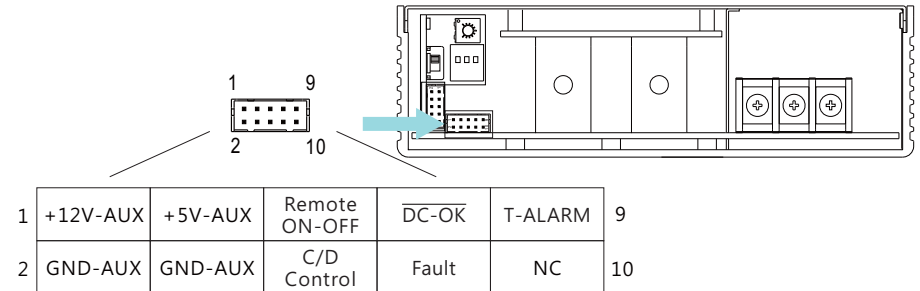

Pin No.	Function	Description
1	+12V-AUX	Auxiliary voltage output, 11.4~12.6V, referenced to GND-AUX (pin 2,4). The maximum output current is 0.5A. This output is not controlled by the Remote ON/OFF control.
2,4	GND-AUX	Auxiliary voltage output GND. The signal return is isolated from the output terminals (+V & -V).
3	+5V-AUX	Auxiliary voltage output, 4.5~5.5V, referenced to GND-AUX (pin 2,4) only for Remote ON/OFF used. This output is not controlled by the Remote ON/OFF control.



Pin No.	Function	Description
5	Remote ON-OFF	The unit can turn the output ON/OFF by electrical signal or dry contact between Remote ON/OFF and +5V-AUX(pin 3). (Note.1)
6	C/D Control (Note.2)	High (4.5 ~ 5.5V) : Battery Charging mode Low (-0.5 ~ 0.5V) : Battery Discharging mode (Note.1)
7	DC-OK	High (4.5 ~ 5.5V) : When the $V_{out} \leq 80\% \pm 5\%$ . Low (-0.5 ~ 0.5V) : When $V_{out} \geq 80\% \pm 5\%$ . The maximum sourcing current is 4mA and only for output.
8	Fault	High (4.5 ~ 5.5V) : When the $V_{ac} \leq 165V_{rms}$ , OLP, SCP, OTP, OVP, AC Fail, fan lock, islanding protection. Low (-0.5 ~ 0.5V) : When $V_{ac} \geq 175V_{rms}$ and when power supply work normally. The maximum sourcing current is 4mA and only for output. (Note.1)
9	T-ALARM	High (4.5 ~ 5.5V) : When the internal temperature exceeds the limit of temperature alarm, or when any of the fans fails. Low (-0.5 ~ 0.5V) : When the internal temperature is normal, and when fans work normally. The maximum sourcing current is 4mA and only for output. (Note.1)
10	NC	-----

Note 1 : Isolated signal, referenced to GND-AUX.

Note 2 : CANBus model only.

## 4.4 Pin Assignment of CN47

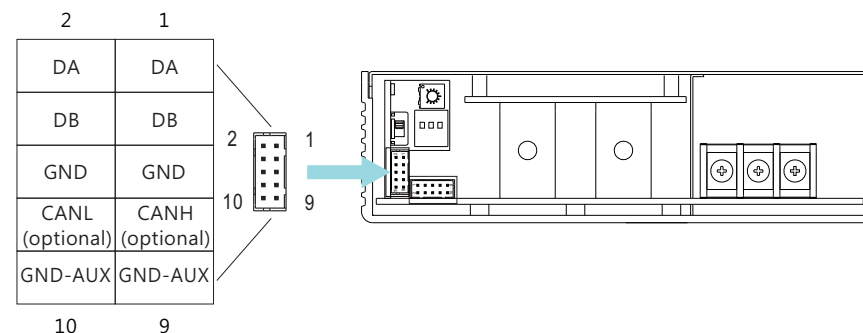

Pin No.	Function	Description
1,2	DA	Differential digital signal for parallel control. (Note.1)
3,4	DB	
5,6	GND	Negative output voltage signal. Certain function reference. It can not be connected directly to the load.
7	CANH (CANBus model)	For CANBus model: Data line used in CANBus interface. (Note.2)
8	CANL (CANBus model)	For CANBus model: Data line used in CANBus interface. (Note.2)
9,10	GND-AUX	Auxiliary voltage output GND. The signal return is isolated from the output terminals (+V & -V).

Note 1 : Non-isolated signal, referenced to GND.

Note 2 : Isolated signal, referenced to GND-AUX.

## 4.5 Function Description of SW50

Parallel connection of the BIC-2200 is by digital differential signals. Units in parallel compensate and stabilize their output through the digital parallel signals. SW50 is a termination resistor which is used to prevent signal reflections, then increasing communication quality. For the usage of SW50, please refer to 5.9 Current Sharing.

## 4.6 Function Description of DIP Switch

Each unit should have their unique and own device address to communicate over CANBus. Please be aware that: This DIP switch only takes effect when the communication interface is used. It is not necessary to set this switch in general use. For details, please refer to 5.10.2 CANBus addressing.

## 5.Operation

BIC-2200 possesses AC to DC and DC to AC two way conversion functions. The conversion direction can be automatically detected and controlled by BIC-2200's internal firmware or manually switched by users according to different application requirements. Before entering detailed function explanation. Please refer to following definitions.

AC to DC (Energy absorbing and charging/ power supplying):

The BIC-2200 converts AC energy from the grid into DC energy for the battery or the loads. The operation principle is the same as an ordinary power supply or a charger.



DC to AC (Energy recycling and discharging):

Opposite to the AC to DC conversion, the BIC-2200 converts DC energy from the battery or loads into AC energy, then feeding back to the grid. AC output synchronization range is 180Vac~264Vac/47Hz~63Hz, the bidirectional power supply can work normally as long as the AC grid is within the range.



## 5.1 Description of Bidirectional Operation

### 5.1.1 Overview

The output range of the BIC-2200 covers DC: 10V – 112V; AC: 180 – 264Vac / 47-63Hz, which can be used to applications with various voltage requirements, such as battery test equipment. To cope with different application occasions, there are two modes for selection, bi-direction auto-detect mode and programmable bi-direction battery mode.

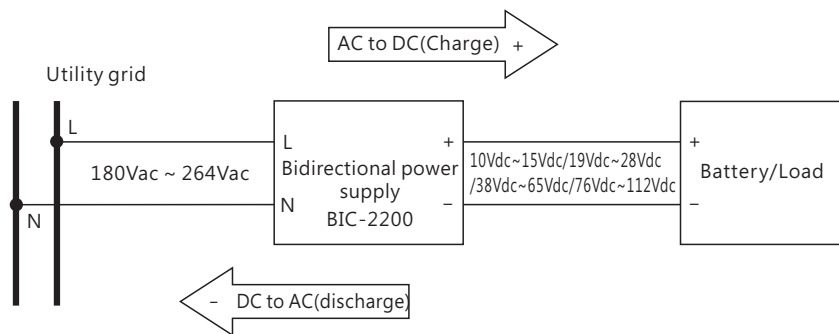

### 5.1.2 Bi-direction auto-detect mode

This is the default factory setting, AC to DC or DC to AC conversion is controlled by BIC-2200 automatically according to operation mechanism below.

- "Target voltage" is the DC voltage setting of the bidirectional supply, when the DC end voltage is different from the "target voltage", the internal firmware will switch between two conversion functions of AC to DC or DC to AC. "Target voltage" is adjustable by the SVR.
- When the "target voltage" is higher than the battery voltage or application equipment voltage, the BIC-2200 operates in AC to DC conversion.
- When the "target voltage" is lower than the battery voltage or application equipment voltage, the BIC-2200 operates in DC to AC conversion.

NOTE: During this mode, AC to DC or DC to AC conversion is judged by the internal firmware. Active control signal (e.g. C/D control) will not take effect in this mode.

Condition	Conversion
$V_{Target} > V_{DC}$	AC to DC
$V_{Target} < V_{DC}$	DC to AC

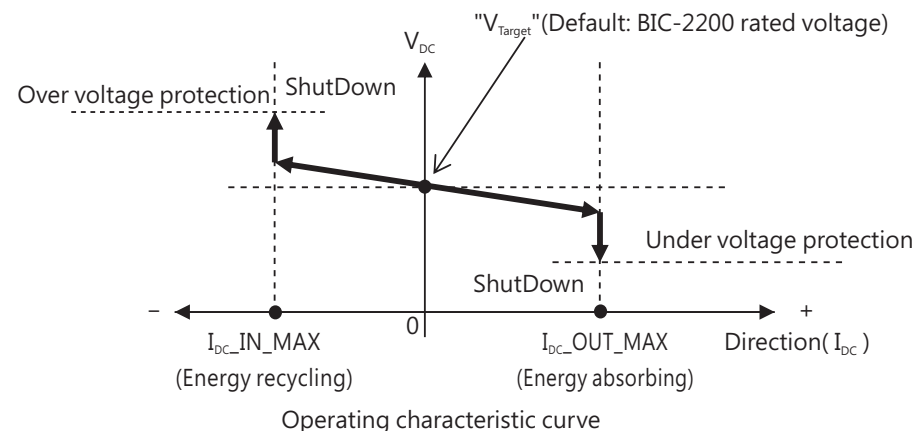

### 5.1.3 Bi-direction battery mode

This option only works with CANBus model, and with its communication interface. To activate the mode, please follow below:

1. Set command SYSTEM\_CONFIG(0x00C2) at 0x0003 → Activate CANBus communication mode.
2. Set command BIDIRECTIONAL\_CONFIG(0x0140) at 0x0001 → Set at bi-direction battery mode.
3. Repower on the supply to activate the battery mode

NOTE: For detailed CANBus information, please refer to 5.10 CANBus Protocol

After bi-direction battery mode is activated, users can switch the supply between AC to DC or DC to AC conversion by CANBus command (digital) or C/D control (analogy). Please refer to 5.1.3.1 CANBus command (digital) and 5.1.3.2 C/D control (analogy)

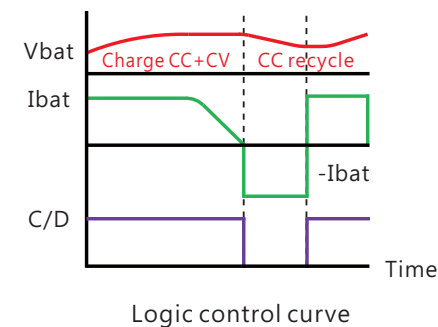

Logic control curve

### 5.1.3.1 CANBus command (digital)

The users can set the supply in AC to DC (charging) or DC to AC (discharging) conversion directly through command DIRECTION\_CTRL (0x0100). Command VOUT\_SET(0x0020) and IOUT\_SET(0x0030) are used to adjust values of charge voltage and charge current in AC to DC conversion. Command REVERSE\_VOUT\_SET(0x0120) REVERSE\_IOUT\_SET(0x0130) are used to adjust values of discharging voltage and discharging current in DC to AC conversion.

Command	Conversion
DIRECTION_CTRL = 00h	AC to DC(charging)
DIRECTION_CTRL = 01h	DC to AC(discharging)

NOTE: Please refer to 5.10.4 CANBus value range and tolerance for detailed information about adjustable ranges of VOUT\_SET, IOUT\_SET, REVERSE\_VOUT\_SET and REVERSE\_IOUT\_SET.

### 5.1.3.2 C/D Control (analogy)

The users also can control AC to DC (charging) or DC to AC (discharging) conversion via analogy signals. To activate the mode, please follow the steps below:

1. Set command BIDIRECTIONAL\_CONFIG(0x0140) at "1" → Activate battery mode.

2. Set desired target voltage through

VOUT\_SET(0x0020)/REV\_VOUT\_SET(0x0120) and AC/DC and DC/AC current through IOUT\_SET(0x0030)/REV\_IOUT\_SET(0x0130)  
 AC/DC parameters: VOUT\_SET(0x0020)/ IOUT\_SET(0x0030)  
 DC/AC parameters: REV\_VOUT\_SET(0x0120)/ REV\_IOUT\_SET (0x0130)

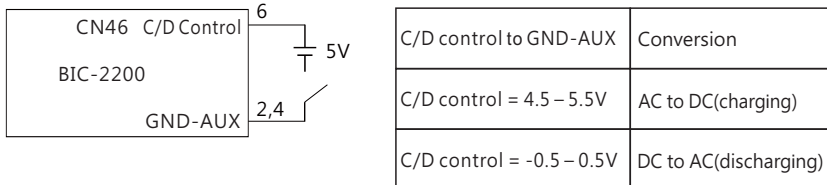

NOTE: Please make sure CAN\_CTRL(Bit 0) of SYSTEM\_CONFIG(0x00C2) is set at "0" in order not to interfere in C/D control.

### 5.1.3.3 Notes on battery mode

In bi-direction battery mode, although users can determine direction of the conversions on their demand, however if the setting voltage does not match the actual DC end voltage, AC to DC (charging) or DC to AC (discharging) conversion may not work as expected. Here are examples that will cause conversion errors.

1. During AC to DC conversion (C/D control = High or DIRECTION\_CTRL = 00h), if battery voltage is higher than the value of command VOUT\_SET (charge voltage), the BIC-2200 will perform DC to AC conversion instead, but limiting discharge current at 5% of rated current. If you want to ensure AC to DC conversion working properly, please make sure value of command VOUT\_SET is higher than the battery voltage.
2. During DC to AC conversion (C/D control =Low or DIRECTION\_CTRL = 01h), if battery voltage is lower than the value of command VOUT\_SET\_REV, the BIC-2200 will perform AC to DC conversion instead, but then limiting charge current at 5% of rated current. To ensure DC to AC conversion working properly, please make sure value of command VOUT\_SET\_REV is lower than the battery voltage.

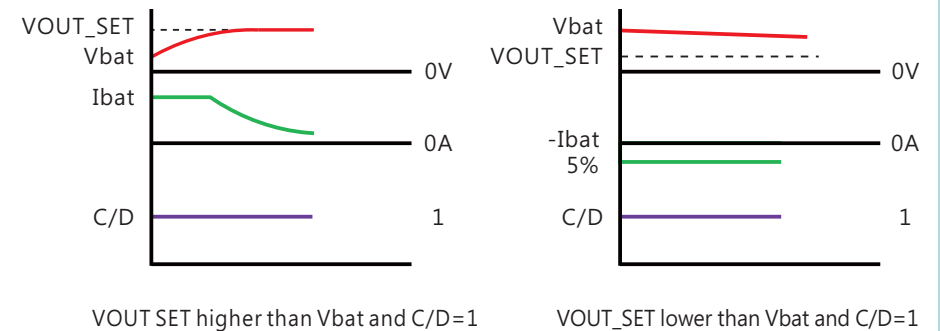

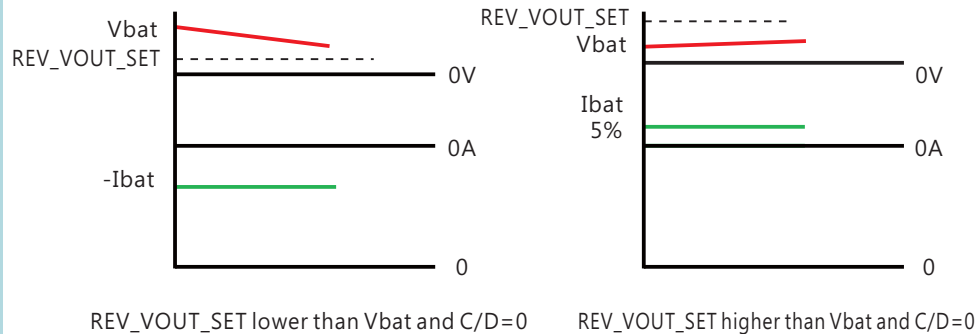

## 5.2 Inrush Current Limiting

- Built-in AC inrush current limiting circuit
- Since the inrush current limiting circuit mainly consists of a NTC thermistor and a relay, inrush current will be much higher than the specified value if the thermistor in AC side is not allowed sufficient time to cool down. After turning off the supply, a 10 second cool down period is recommended before turning on again.

## 5.3 Power Factor Correction (PFC)

- Built-in active power factor correction (PFC) function, power factor (PF) will be 0.95 or better at full load condition in AC to DC or DC to AC conversion. PF will be less than 0.95 if it is not at full load condition during AC to DC or DC to AC conversion.

## 5.4 Fan Speed control

- Built-in fan speed control circuit, fan speed changes automatically depending on internal temperature.

## 5.5 Fault Signal

- Fault signal is used to inform application equipment that whether it is energy recyclable. When it is OLP, SCP or OTP, BIC-2200 will send a high level of fault signal 100ms in advance to notify the application before shutting down the supply. A fault signal will send out at the same time of shutting down operation in the reset of protection (e.g. AC\_fail).
- Maximum output current 4mA.

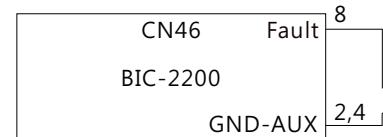

CN46 Fault to GND-AUX	Condition
-0.5~0.5V	Normal working
4.5~5.5V	Not energy recyclable

## 5.6 (DC-OK) Signal

- Built-in DC output voltage detection circuit.
- Maximum output current 4mA.

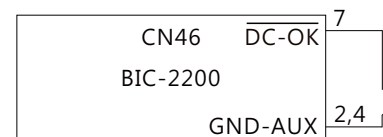

CN46 DC-OK to GND-	Condition
-0.5~0.5V	DC OK
4.5~5.5V	Abnormal in DC

## 5.7 Remote Control

- Built-in remote ON/OFF control circuit, which is used to turn on/off the supply.
- Please be aware that "remote ON/OFF and "+5V-AUX" on CN46 should be linked together to allow the unit to operate normally; if kept open, there will be no output.
- Maximum input voltage 5.5V.

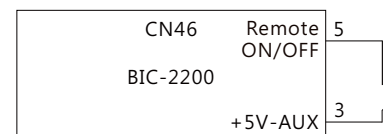

CN46 Remote ON/OFF to +5V-AUX	Condition
-0.5~0.5V	ON
4.5~5.5V	OFF

## 5.8 Auxiliary Output

- Built-in 12V/0.5A auxiliary output



## 5.9 Parallel Operation

BIC-2200 has the built-in active current sharing function and can be connected in parallel, up to 5 units, to provide higher output power as exhibited below:

- The power supplies should be paralleled using short and large diameter wiring and then connected to the load.
- In parallel connection, power supply with the highest output voltage will be the master unit and its  $V_{out}$  will be the DC bus voltage.
- The total output current must not exceed the value determined by the following equation:  

$$\text{Maximum output current at parallel operation} = (\text{Rated current per unit}) \times (\text{Number of unit}) \times 0.95$$
- When the total output current is less than 5% of the total rated current, or say (5% of Rated current per unit)  $\times$  (Number of unit) the current shared among units may not be balanced.
- Under parallel operation ripple of the output voltage may be higher than the SPEC at light load condition, It will go back to normal ripple level once the output load is more than 5%.
- CN47/SW50 Function pin connection

Parallel	PSU1		PSU2		PSU3		PSU4		PSU5	
	CN47	SW50	CN47	SW50	CN47	SW50	CN47	SW50	CN47	SW50
1 unit	X	ON	—	—	—	—	—	—	—	—
2 unit	V	ON	V	ON	—	—	—	—	—	—
3 unit	V	ON	V	OFF	V	ON	—	—	—	—
4 unit	V	ON	V	OFF	V	OFF	V	ON	—	—
5 unit	V	ON	V	OFF	V	OFF	V	OFF	V	ON

(V : CN47 connected ; X : CN47 not connected)

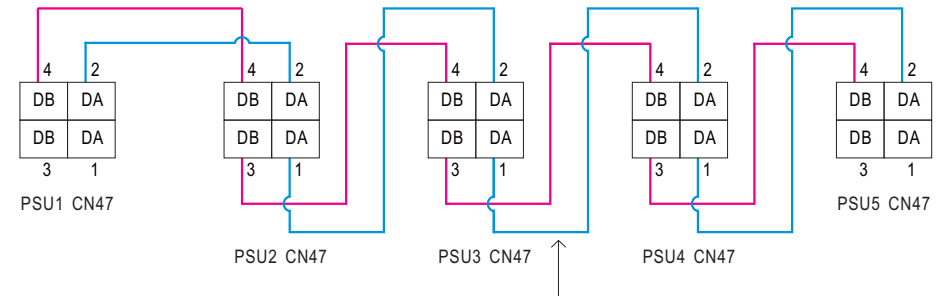
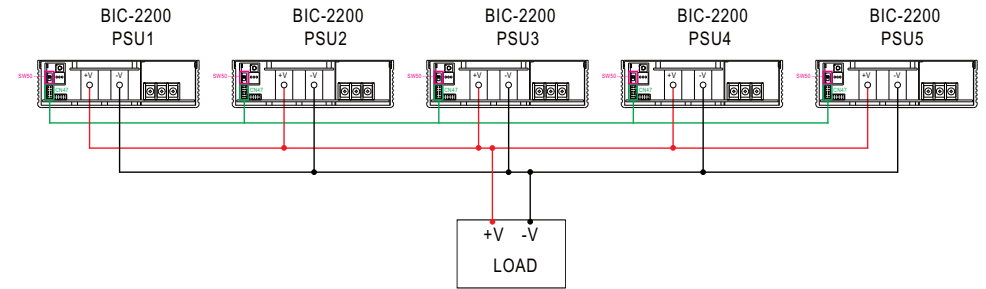

If the lines of CN47 are too long, they should be twisted in pairs to avoid the noise.

© DA · DB Connected mutually in parallel

## 5.10 CANBus Protocol

CANBus communication interface provides control and monitoring functions. It is helpful when users intent to modify the parameters remotely. Users can read and write the parameters through the bus, which includes bi-directional battery mode switch, ON/OFF, charge voltage/ current, discharge voltage/ current, temperature, etc.

### 5.10.1 CANBus Specification

- Physical layer specification  
This protocol follows CAN ISO-11898 with Baud rate of 250Kbps.
- Data Frame  
This protocol utilizes Extended CAN 29-bit identifier frame format or CAN 2.0B.

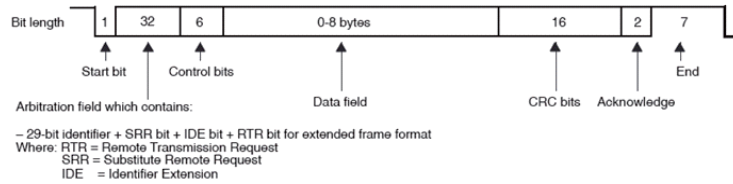

- Communication Timing  
Min. request period (Controller to BIC-2200): 20mSec  
Max. response time (BIC-2200 to Controller): 5mSec  
Min. packet margin time (Controller to BIC-2200): 5mSec

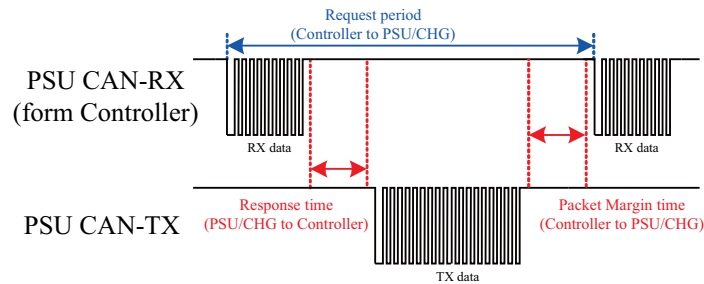

### Data Field Format

Controller to BIC

Write:

Data filed bytes

0	1	2	3
COMD. low byte	COMD. high byte	Data low byte	Data high byte

Read:

Data filed bytes

0	1
COMD. low byte	COMD. high byte

BIC to Controller

Response:

Data filed bytes

0	1	2	...	7
COMD. low byte	COMD. high byte	Data low 1	.....	Data high 6

NOTE: BIC will not send data back when write parameters, such as VOUT\_SET

### 5.10.2 CANBus Addressing

Each BIC-2200 unit should have their unique and own device address to communicate over the CANBus. PIN 1 - PIN 3 of the DIP switch allows users to designate an address for their supply units (with maximum of 8 addresses). Please refer to below for the detailed setup advice.



Model No.	DIP switch position		
	1	2	3
0	ON	ON	ON
1	OFF	ON	ON
2	ON	OFF	ON
3	OFF	OFF	ON
4	ON	ON	OFF
5	OFF	ON	OFF
6	ON	OFF	OFF
7	OFF	OFF	OFF

### 5.10.3 CANBus command list

Command Code	Command Name	Transaction Type	# of data Bytes	Description
0x0000	OPERATION	R/W	1	01:ON/00:OFF
0x0020	VOUT_SET*	R/W	2	Charge voltage setting (format: value, F=0.01)
0x0030	IOUT_SET*	R/W	2	Charge current setting (format: value, F=0.01)
0x0040	FAULT_STATUS	R	2	Summary status reporting
0x0050	READ_VIN	R	2	AC voltage reading value (format: value, F=0.1)
0x0060	READ_VOUT	R	2	DC voltage reading value Note. i(format: value, F=0.01)
0x0061	READ_IOUT	R	2	DC current reading value (format: value, F=0.01)
0x0062	READ_TEMPERATURE_1	R	2	Internal ambient temperature (format: value, F=0.1)
0x0070	READ_FAN_SPEED_1	R	2	Fan speed 1 reading value (format: value, F=1)
0x0071	READ_FAN_SPEED_2	R	2	Fan speed 2 reading value (format: value, F=1)
0x0080	MFR_ID_B0B5	R	6	Manufacturer's name
0x0081	MFR_ID_B6B11	R	6	Manufacturer's name
0x0082	MFR_MODEL_B0B5	R	6	Manufacturer's model name
0x0083	MFR_MODEL_B6B11	R	6	Manufacturer's model name
0x0084	MFR_REVISION_B0B5	R	6	Firmware revision
0x0085	MFR_LOCATION_B0B2	R/W	3	Manufacturer's factory location
0x0086	MFR_DATE_B0B5	R/W	6	Manufacturer's date
0x0087	MFR_SERIAL_B0B5	R/W	6	Product serial number
0x0088	MFR_SERIAL_B6B11	R/W	6	Product serial number

Command Code	Command Name	Transaction Type	# of data Bytes	Description
0x00C0	SCALING_FACTOR	R	2	Scaling ratio
0x00C1	SYSTEM_STATUS	R	2	System status
0x00C2	SYSTEM_CONFIG	R/W	2	System configuration
0x0100	DIRECTION_CTRL	R/W	1	A/D or D/A conversion control 00: A/D 01: D/A
0x0120	REVERSE_VOUT_SET*	R/W	2	Discharge voltage setting (format: value, F=0.01)
0x0130	REVERSE_IOUT_SET*	R/W	2	Discharge current setting (format: value, F=0.01)
0x0140	BIDIRECTIONAL_CONFIG	R/W	2	Bidirectional mode configuration

NOTE: Setting commands with \* at the end support the EEP\_OFF and EEP\_CONFIG functions. For detailed information on how to enable them, please refer to SYSTEM\_CONFIG (0x00C2).

#### Data conversion:

The conversion of setting and reading values is defined as following:  
Actual value = Communication reading value × Factor (F value). Among them, Factor needs to refer to the definition of SCALING\_FACTOR in each model list.  
EX: VDC\_real (actual DC voltage) = READ\_VOUT × Factor.

If the Factor of READ\_VOUT of a certain model is 0.01, the communication reading value is 0x0960 (hexadecimal) → 2400 (decimal), then VDC\_real = 2400 × 0.01 = 24.00V.

#### Message ID definition:

Description	Message ID
BIC-2200 to controller Message ID	0x000C02XX
Controller to BIC-2200 Message ID	0x000C03XX
Controller broadcasts to BIC-2200 Message ID	0x000C03FF

Note : XX means the address of BIC-2200 ( which can be assigned by the DIP switch, range from 0x00 ~ 0x07)



FAULT\_STATUS(0x0040):

High byte	Bit 7	Bit 6	Bit 5	Bit 4	Bit 3	Bit 2	Bit 1	Bit 0
Definition	---	---	---	---	---	---	---	HV_OVP
Low byte	Bit 7	Bit 6	Bit 5	Bit 4	Bit 3	Bit 2	Bit 1	Bit 0
Definition	HI_TEMP	OP_OFF	AC_FAIL	SHORT	OLP	OVP	OTP	FAN_FAIL

Low byte :

- Bit 0 FAN\_FAIL : Fan locked flag**  
0 = Fan working normally  
1 = Fan locked
- Bit 1 OTP : Over temperature protection**  
0 = Internal temperature normal  
1 = Internal temperature abnormal
- Bit 2 OVP : DC over voltage protection**  
0 = DC voltage normal  
1 = DC over voltage protected
- Bit 3 OLP : DC over current protection**  
0 = DC current normal  
1 = DC over current protected
- Bit 4 SHORT : Short circuit protection**  
0 = Shorted circuit do not exist  
1 = Shorted circuit protected
- Bit 5 AC\_FAIL : AC abnormal flag**  
0 = AC range normal  
1 = AC range abnormal
- Bit6 OP\_OFF : DC status**  
0 = DC turned on  
1 = DC turned off
- Bit7 HI\_TEMP : Internal high temperature alarm**  
0 = Internal temperature normal  
1 = Internal temperature abnormal

High byte :

- Bit 0 HV\_OVP : HV over voltage protection**  
0 = HV voltage normal  
1 = HV over voltage protected

MFR\_ID\_B0B5(0x0080) is the first 6 codes of the manufacturer's name (ASCII);MFR\_ID\_B6B11(0x0081) is the last 6 codes of the manufacturer's name (ASCII)

EX: manufacturer's name is MEANWELL → MFR\_ID\_B0B5 is MEANWE ; MFR\_ID\_B6B11 is LL

MFR_ID_B0B5						MFR_ID_B6B11					
Byte 0	Byte 1	Byte 2	Byte 3	Byte 4	Byte 5	Byte 0	Byte 1	Byte 2	Byte 3	Byte 4	Byte 5
0x4D	0x45	0x41	0x4E	0x57	0x45	0x4C	0x4C	0x20	0x20	0x20	0x20

MFR\_MODEL\_B0B5(0x0082) is the first 6 codes of the manufacturer's model name(ASCII); MFR\_MODEL\_B6B11(0x0083) is the last 6 codes of the manufacturer's model name (ASCII)

EX: Model name is BIC-2200-24 → MFR\_MODEL\_B0B5 is BIC-22 ; MFR\_MODEL\_B6B11 is 00-24

MFR_MODEL_B0B5						MFR_MODEL_B6B11					
Byte 0	Byte 1	Byte 2	Byte 3	Byte 4	Byte 5	Byte 6	Byte 7	Byte 8	Byte 9	Byte 10	Byte 11
0x42	0x49	0x43	0x2D	0x32	0x32	0x30	0x30	0x2D	0x32	0x34	0x20

MFR\_REVISION\_B0B5(0x0084) is the firmware revision (hexadecimal). A range of 0x00(R00.0)~0xFE (R25.4) represents the firmware version of an MCU; 0xFF represents no MCU existed

EX: The supply has two MCUs, the firmware version of the MCU number 1 is version R25.4 (0xFE), the MCU number 2 is version R10.5 (0x69)

Byte 0	Byte 1	Byte 2	Byte 3	Byte 4	Byte 5
0xFE	0x69	0xFF	0xFF	0xFF	0xFF

MFR\_DATE\_B0B5(0x0086) is manufacture date (ASCII)

EX: MFR\_DATE\_B0B5 is 180101, meaning 2018/01/01

Byte 0	Byte 1	Byte 2	Byte 3	Byte 4	Byte 5
0x31	0x38	0x30	0x31	0x30	0x31

MFR\_SERIAL\_BOB5(0x0087) and MFR\_SERIAL\_B6B11(0x0088) are defined as manufacture date and manufacture serial number (ASCII)

EX: The first unit manufactured on 2018/01/01 → MFR\_SERIAL\_BOB5:

180101 ; MFR\_SERIAL\_B6B11: 000001

MFR_ID_BOB5						MFR_ID_B6B11					
Byte 0	Byte 1	Byte 2	Byte 3	Byte 4	Byte 5	Byte 6	Byte 7	Byte 8	Byte 9	Byte 10	Byte 11
0x31	0x38	0x30	0x31	0x30	0x31	0x30	0x30	0x30	0x30	0x30	0x31

SCALING\_FACTOR(0x00CO):

Byte 4~5	Bit 7~Bit 0							
Definition	---							
Byte 3	Bit 7	Bit 6	Bit 5	Bit 4	Bit 3	Bit 2	Bit 1	Bit 0
Definition	--				IIN Factor			
Byte 2	Bit 7	Bit 6	Bit 5	Bit 4	Bit 3	Bit 2	Bit 1	Bit 0
Definition	--				TEMPERATURE_1 Factor			
Byte 1	Bit 7	Bit 6	Bit 5	Bit 4	Bit 3	Bit 2	Bit 1	Bit 0
Definition	FAN_SPEED Factor				VIN Factor			
Byte 0	Bit 7	Bit 6	Bit 5	Bit 4	Bit 3	Bit 2	Bit 1	Bit 0
Definition	IOOUT Factor				VOOUT Factor			

byte 0 :

**Bit 0 : 3 VOUT Factor : The Factor of DC voltage**

- 0x0=DC voltage relevant commands not supported
- 0x4=0.001
- 0x5=0.01
- 0x6=0.1
- 0x7=1.0
- 0x8=10
- 0x9=100

**Bit 4 : 7 IOOUT Factor : The Factor of DC current**

- 0x0=DC current relevant commands not supported
- 0x4=0.001
- 0x5=0.01
- 0x6=0.1
- 0x7=1.0
- 0x8=10
- 0x9=100

byte 1 :

**Bit 0 : 3 VIN Factor : The Factor of AC voltage**

- 0x0=AC voltage relevant commands not supported
- 0x4=0.001
- 0x5=0.01
- 0x6=0.1
- 0x7=1.0
- 0x8=10
- 0x9=100

**Bit 4 : 7 FAN\_SPEED Factor : The Factor of fan speed**

- 0x0=Fan speed relevant commands not supported
- 0x4=0.001
- 0x5=0.01
- 0x6=0.1
- 0x7=1.0
- 0x8=10
- 0x9=100

byte 2 :

**Bit 0 : 3 TEMPERATURE\_1 Factor : The Factor of internal ambient temperature**

- 0x0=internal ambient temperature relevant commands not supported
- 0x4=0.001
- 0x5=0.01
- 0x6=0.1
- 0x7=1.0
- 0x8=10
- 0x9=100

byte 3 :

**Bit 0 : 3 IIN Factor : The Factor of AC current**

- 0x0=AC current relevant commands not supported
- 0x4=0.001
- 0x5=0.01
- 0x6=0.1
- 0x7=1.0
- 0x8=10
- 0x9=100
- 0xA~0xF= Reserved

SYSTEM\_STATUS(0x00C1):

High byte	Bit 7	Bit 6	Bit 5	Bit 4	Bit 3	Bit 2	Bit1	Bit 0
Definition	---	---	---	---	---	---	---	---
Low byte	Bit 7	Bit 6	Bit 5	Bit 4	Bit 3	Bit 2	Bit1	Bit 0
Definition	---	EEPER	INITIAL_STATE	ADL_ON	---	PFC_OK	DC_OK	M/S

Low byte :

**Bit 0 M/S : parallel mode status**

- 0 = Current device is Slave
- 1 = Current device is Master

**Bit 1 DC\_OK : Secondary DD output voltage status**

- 0 = Secondary DD output voltage status TOO LOW
- 1 = Secondary DD output voltage status NORMAL

**Bit 2 PFC\_OK : Primary PFC status**

- 0 = Primary PFC OFF or abnormal
- 1 = Primary PFC ON normally

**Bit 4 ADL\_ON : Active dummy load control status**

- 0 = Active dummy load off/function not supported
- 1 = Active dummy load on

**Bit 5 INITIAL\_STATE: Device initialized status**

- 0 = In initialization status
- 1 = NOT in initialization status

**Bit6 EEPER : EEPROM data access error**

- 0 = EEPROM data access normal
- 1 = EEPROM data access error

※ When an EEPROM data access error occurs, the supply shuts down and then entering protection mode with the LED indicator off. It only can be recovered after the EEPROM error condition is resolved.

SYSTEM\_CONFIG(0x00C2):

High byte	Bit 7	Bit 6	Bit 5	Bit 4	Bit 3	Bit 2	Bit1	Bit 0
Definition	---	---	---	---	---	EEP_OFF	EEP_CONFIG	
Low byte	Bit 7	Bit 6	Bit 5	Bit 4	Bit 3	Bit 2	Bit1	Bit 0
Definition	---	---	---	---	---	OPERATION_INIT		CAN_CTRL

Low byte :

**Bit 0 CAN\_CTRL : CANBus communication control status**

- 0 = The output voltage/current defined by control over SVR
- 1 = The output voltage, current, ON/OFF control defined by control over CANBus (VOUT\_SET, IOU\_SET, OPERATION)

**Bit1 : 2 OPERATION\_INIT : Pre-set value of power on operation command**

- 0b00 = Power OFF, pre-set 0x00(OFF)
- 0b01 = Power ON, pre-set 0x01(ON)
- 0b10 = Pre-set is previous set value
- 0b11 = not used, reserved

High Byte

**Bit 0 : 1 EEP\_CONFIG : EEPROM Configuration**

- 00: Immediate. Changes to parameters are written to EEPROM immediately (factory default)
- 01: 1 minute delay. Write changes to EEPROM if all parameters remain unchanged for 1 minute
- 10: 10 minute delay. Write changes to EEPROM if all parameters remain unchanged for 10 minutes
- 11: Reserved

**Bit 2 EEP\_OFF : EEPROM storage function ON/OFF**

- 0: Enable. Parameters to be saved into EEPROM (factory default)
- 1: Disable. Parameters NOT to be saved into EEPROM

BIDIR\_CONFIG(0x0140):

High byte	Bit 7	Bit 6	Bit 5	Bit 4	Bit 3	Bit 2	Bit1	Bit 0
Definition	---	---	---	---	---	---	---	---
Low byte	Bit 7	Bit 6	Bit 5	Bit 4	Bit 3	Bit 2	Bit1	Bit 0
Definition	---	---	---	---	---	---	---	MODE

Low byte :

**Bit 0 MODE: Bidirectional mode configuration**

- 0 = Bi-direction auto-detect mode. DIR\_CTRL and C/D control (analogy) UN-controllable.
- 1 = Bi-direction battery mode. DIR\_CTRL and C/D control (analogy) controllable

### 5.10.4 Communication Examples

The following provides examples of command sending and data reading for the CAN bus protocol.

#### 5.10.4.1 Sending command

The master adjusts output voltage of the unit with address "00" to 30V.

CAN ID	DLC(data length)	Command code	Data
0x000C0300	0x4	0x2000	0xB80B

Command code: 0x0020(VOUT\_SET) → 0x20(Lo) + 0x00(Hi)

Data: 30V → 3000 → 0x0BB8 → 0xB8(Lo) + 0x0B(Hi)

NOTE: Conversion factor for VOUT\_SET is 0.01, so  $\frac{30V}{F0.01} = 3000$

#### 5.10.4.2 Reading data or status

The master reads operation setting from the unit with address "01"

CAN ID	DLC(data length)	Command code
0x000C0301	0x2	0x0000

The unit with address "01" returns data below:

CAN ID	DLC(data length)	Command code	Data
0x000C0201	0x3	0x0000	0x01

Data: 0x01 ON, meaning that the unit with address "01" is operating.

#### 5.10.4.3 Practical Operation of Communication Mode

The following steps will describe how to set the BIC-2200-48 to communication mode and adjust its voltage/current, with VOUT\_SET: 60V, IOUIT\_SET: 20A and REVERSE\_IOUIT\_SET: -20A.

1. Set the ID of the BIC-2200 to "0", that is setting the DIP switch to ON/ON/ON positions.



2. Connect the CANH/CANL pins of the master to the corresponding CANH(PIN7) and CANL(PIN8) pins of the CN47 connector on the supply. It is recommended to establish a common ground for the communication system to increase its communication reliability by using GND-AUX (PIN9) of CN47.

◎ Set baud rate: 250kbps, type: extended

◎ Adding a 120Ω terminal resistor to both the controller and BIC-2200 ends can increase communication stability

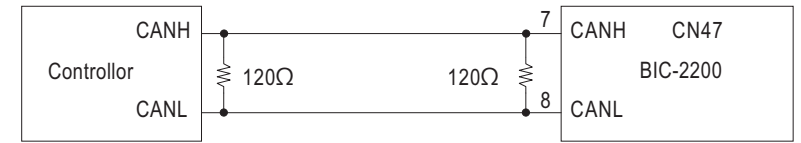

3. Configure communication settings after power on in remote off mode. Enable communication mode and set power ON when AC connected.

CAN ID	DLC(data length)	Command code	Parameters
0x000C0300	0x04	0xC200	0x0300

Command code: 0x00C2(SYSTEM\_CONFIG) → 0xC0 (Lo) + 0x00(Hi)  
Parameters: 03(Lo) + 00(Hi) · Please refer to definition of SYSTEM\_CONFIG for detailed information.

4. Set VOUT\_SET to 60V.

CAN ID	DLC(data length)	Command code	Parameters
0x000C0300	0x04	0x2000	0x7017

Command code: 0x0020(VOUT\_SET) → 0x20 (Lo) + 0x00(Hi)

Parameters: 60V → 6000 → 0x1770 → 0x70(Lo) + 0x17(Hi)

NOTE: Conversion factor for VOUT\_SET is 0.01 · so  $\frac{60V}{F0.01} = 6000$

5. Set IOUIT\_SET to 20A.

CAN ID	DLC(data length)	Command code	Parameters
0x000C0300	0x04	0x3000	0xD007

Command code: 0x0030(IOUIT\_SET) → 0x30 (Lo) + 0x00(Hi)

Parameters: 20A → 2000 → 0x07D0 → 0xD0(Lo) + 0x07(Hi)

NOTE: Conversion factor for VOUT\_SET is 0.01 · so  $\frac{20A}{F0.01} = 2000$

## 6. Set REVERSE\_IOUT\_SET to -20A.

CAN ID	DLC(data length)	Command code	Parameters
0x000C0300	0x04	0x3001	0xD007

Command code: 0x0130(REVERSE\_IOUT\_SET) → 0x30 (Lo) + 0x01(Hi)

Parameters: 20A → 2000 → 0x07D0 → 0xD0(Lo) + 0x07(Hi)

NOTE: Conversion factor for VOUT\_SET is  $0.01 \cdot \frac{20A}{F0.01} = 2000$

7. Before connecting to the batteries or loads, it is recommended to review all of the settings and parameters using the appropriate commands. In the event that they do not meet your requirements, you may rewrite them as needed.

EX: Read IOUT\_SET to check whether current level for AC to DC was set to a proper level.

Read IOUT\_SET

CAN ID	DLC(data length)	Command code
0x000C0300	0x02	0x3000

The unit returns data below

CAN ID	DLC(data length)	Command code	Parameters
0x000C0200	0x04	0x3000	0xD007

Parameters: 0xD0(Lo) + 0x07(Hi) → 0x07D0 → 6000 →  $6000 \times 0.01(F) = 20A$

8. Finally, short circuit ON-OFF (PIN5) and +5-AUX (PIN3) pins of the CN46 connector on the supply to remote on it to charge the batteries or provide energy to the loads.

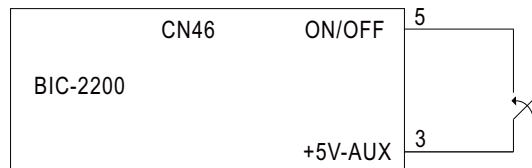

## 5.10.5 CANBus value range and tolerance:

## (1) Display parameters

CANBus Command		Model	Display value range	Tolerance
0x0050	READ_VIN	ALL	180~264V	±10V
0x0060	READ_VOUT	12V	0~15V	±0.12V
		24V	0~28V	±0.24V
		48V	0~56V	±0.48V
		96V	0~112V	±0.96V
0x0061	READ_IOUT	12V	-180~216A	±1.8A
		24V	-90~108A	±0.9A
		48V	-45~54A	±0.45A
		96V	-22.5~27A	±0.25A
0x0062	READ_TEMPERATURE_1	ALL	-40~110°C	±5°C
0x0070	READ_FAN_SPEED_1	ALL	0 ~ 25000RPM	±2000RPM
0x0071	READ_FAN_SPEED_2	ALL	0 ~ 25000RPM	±2000RPM

## (2) Control parameters (Bi-direction auto-detect mode)

CANBus Command		Model	Adjustable range	Tolerance	Default
0x0000	OPERATION	ALL	00h(OFF)/01h(ON)	N/A	01h(ON)
0x0020	VOUT_SET	12V	10~15V	±0.12V	12V
		24V	19~28V	±0.24V	24V
		48V	38~65V	±0.48V	48V
		96V	76~112V	±0.96V	96V
0x0120	REVERSE_VOUT_SET	12V	10~15V	±0.12V	10V
		24V	19~28V	±0.24V	19V
		48V	38~65V	±0.48V	38V
		96V	76~112V	±0.96V	76V
0x0030	IOUT_SET	12V	+1.8~+198A	±1.8A	198A
		24V	+0.9~+99A	±0.9A	99A
		48V	+0.45~+49.5A	±0.45A	49.5A
		96V	+0.25~+24.75A	±0.25A	24.75A
0x0130	REVERSE_IOUT_SET	12V	-153~-1.8A	±1.8A	-153A
		24V	-76.5~-0.9A	±0.9A	-76.5A
		48V	-38.3~-0.45A	±0.45A	-38.3A
		96V	-19.1~-0.25A	±0.25A	-19.1A
0x0140	BIDIRECTIONAL_CONFIG	ALL	00h(CV)/01h(Battery)	N/A	00h(CV)
0x00C2	SYSTEM_CONFIG	ALL	N/A	N/A	02h
0x0000	OPERATION	ALL	00h(OFF)/01h(ON)	N/A	01h(ON)

### (3)Control parameters (Bi-direction battery mode)

CANBus Command		Model	Adjustable range	Tolerance	Default
0x0100	DIRECTION_CTRL	ALL	00h(Charge)/ 01h(Discharge)	N/A	00h(Charge)
0x0020	VOUT_SET	12V	10~15V	±0.12V	12.6V
		24V	19~28V	±0.24V	25.2V
		48V	38~65V	±0.48V	50.4V
		96V	76~112V	±0.96V	100.8V
0x0120	REVERSE_VOUT_SET	12V	10~15V	±0.12V	10V
		24V	19~28V	±0.24V	19V
		48V	38~65V	±0.48V	38V
		96V	76~112V	±0.96V	76V
0x0030	IOUT_SET	12V	+1.8~+180A	±1.8A	160A
		24V	+0.9~+90A	±0.9A	80A
		48V	+0.45~+45A	±0.45A	40A
		96V	+0.25~+22.5A	±0.25A	20A
0x0130	REVERSE_IOUT_SET	12V	-153~-1.8A	±1.8A	-120A
		24V	-76.5~-0.9A	±0.9A	-64.3A
		48V	-38.3~-0.45A	±0.45A	-32.2A
		96V	-19.1A~-0.25A	±0.25A	-16.1A
0x0140	BIDIRECTIONAL_CONFIG	ALL	00h(AD)/01h(BAT.)	N/A	00h(AD)
0x00C2	SYSTEM_CONFIG	ALL	N/A	N/A	02h

#### NOTE:

- i. Owing to the limited write cycles of the EEPROM, it is advisable to consider using the SYSTEM\_CONFIG (0x00C2) command to select an appropriate EEPROM writing logic, especially if communication settings are frequently altered.
- ii. Changing parameters to BIDIR\_CONFIG(0x0140) command require a reboot to take effect.

## 5.11 Restore Factory Default Setting

Users could set the device into factory default by following steps (command 0x0000, 0x0020, 0x0120, 0x0030, 0x0130, 0x0140, 0x00C2):

- (1) Set all DIP switch positions (device address) to ON.
- (2) Power on in REMOTE OFF mode (no output at this step).
- (3) After power on, in 15 seconds, switch all DIP switch from ON to OFF and then switch ALL back to ON position.
- (4) Green LED will blink 3 times if set successfully.
- (5) Turn off the device once and then perform steps (1) to (4) again. The factory default settings will be restored after re-power on.



## 6. Protections and Trouble Shooting

### 6.1 Protections

#### 6.1.1 Anti-islanding Protections

BIC-2200 is designed to refer to IEC 62116(2008), the supply shuts off within 2 seconds when AC is cut or abnormal. Please be aware that it is necessary to install an AC circuit breaker that complies with grid-tie standard in your country before the supply.

#### 6.1.2 Over Temperature Protection (OTP) and Alarm

Built-in thermal detection circuit, once the internal temperature exceeds a threshold value, the supply will shut down automatically (the fans will still be running to cool down the supply). Please switch off the supply, remove all possible causes and then leave the supply cooling down to a normal working temperature (approximate 10 minutes - 1 hour) before repower on again.

Maximum output current 4mA.

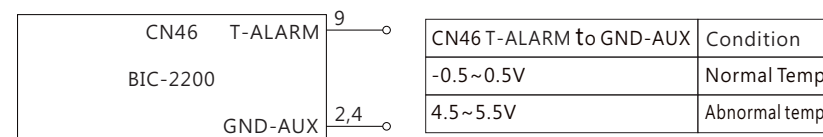

#### 6.1.3 AC Fail Protection

When AC voltage/frequency is abnormal, BIC-2200 will enter protection mode to prevent damaging itself or affect quality of the grid no matter which conversion it is, D/A or A/D. The supply will restore automatically when AC voltage/frequency back to normal.

#### 6.1.4 Short Circuit Protection

When there is short circuit at AC/DC end of BIC-2200, the supply will enter protection mode and shut down. Repower on to restore after short-circuit condition is resolved.

### 6.1.5 Over Current Protection

In AC to DC conversion, when the load current exceeds  $110\% \pm 5\%$  of the rated current, protection mode will be triggered. Repower on to restore after over-current condition is resolved.

### 6.1.6 DC Over Voltage Protection

When the DC end voltage is too high, the DC over-voltage protection circuit will be triggered. Repower on to restore after over-voltage condition is resolved.

## 6.2 Trouble Shooting

Failure State	Possible Cause	Suggested Solution
The supply is not working	Remote OFF	Make sure remote ON/OFF is connected to +5V
AC/DC or DC/AC conversion is incorrect	The setting voltage doesn't match actual DC end voltage	If it is bi-direction auto-detect mode, please refer to 5.1.2. If it is bi-direction battery mode, please refer to 5.1.3.3
LED shows abnormal indication	The ambient temperature too high	Re-start the supply after temperature dropped back
	DC load current too high	Re-start the supply after reducing DC load current
	AC voltage/frequency abnormal	Re-start the supply after AC voltage/frequency is within a normal range
	Battery or load voltage too high	Re-start the supply after DC end voltage is within a normal range

If you are unable to clarify the problem you are facing, please contact MEAN WELL or any of our distributors for repair service.

## 7.Warranty

This product provides five years warranty under normal usage. Do not replace parts or any form of modification to the product in order to keep the warranty effectively.

※ MEAN WELL possesses the right to adjust the content of this manual. Please refer to the latest version of our manual on our website. <https://www.meanwell.com>



## 8.Environmental declaration information

[https://www.meanwell.com//Upload/PDF/RoHS\\_PFOS.pdf](https://www.meanwell.com//Upload/PDF/RoHS_PFOS.pdf)

[https://www.meanwell.com//Upload/PDF/REACH\\_SVHC.pdf](https://www.meanwell.com//Upload/PDF/REACH_SVHC.pdf)

[https://www.meanwell.com//Upload/PDF/Declaration\\_RoHS-E.pdf](https://www.meanwell.com//Upload/PDF/Declaration_RoHS-E.pdf)

明緯企業股份有限公司

MEAN WELL ENTERPRISES CO., LTD.

248 新北市五股區五權三路28號

No.28, Wuquan 3rd Rd., Wugu Dist., New Taipei City 248, Taiwan

Tel:886-2-2299-6100 Fax:886-2-2299-6200

<http://www.meanwell.com> E-mail:[info@meanwell.com](mailto:info@meanwell.com)